

FEATURES

- No opto feedback
- Patents Pending
- Optimised bipolar output voltages for IGBT/ SiC & Mosfet gate drives
- 3 outputs configurable for all gate drive applications: +15V/-5V, +15V/-10V & +20V/-5V outputs
- Reinforced insulation to UL60950 pending
- ANSI/AAMI ES60601-1, 1 MOOP's recognition pending
- Characterised dv/dt immunity 80kV/μs
- Characterised partial discharge performance
- 5.2kVDC isolation test voltage 'Hi Pot Test'
- Ultra low coupling capacitance 15pF
- SMD package
- 5V, 12V & 24V input voltages

PRODUCT OVERVIEW

Offering configurable triple output voltages of +15V, +5V and +5V, the MGJ3 series of DC-DC converters are ideal for powering 'high side' and 'low side' gate drive circuits for IGBTs, Silicon Carbide and Mosfets in bridge circuits.

A choice of asymmetric output voltages allows optimum drive levels for best system efficiency and EMI. The MGJ3 series is characterised for high isolation and dv/dt requirements commonly seen in bridge circuits used in motor drives and inverters. A disable/frequency synchronisation pin, simplifies EMC filter design. The MGJ3 protection features include short circuit protection and overload protection.

SELECTION GUIDE

Order Code	Output 1			Output 2			Output 3		
	Rated Output Voltage	Rated Output Current	Output Power	Rated Output Voltage	Rated Output Current	Output Power	Rated Output Voltage	Rated Output Current	Output Power
	V	mA	W	V	mA	W	V	mA	W
MGJ3T05150505MC	15	120	1.8	5	120	0.6	5	120	0.6
MGJ3T12150505MC	15	120	1.8	5	120	0.6	5	120	0.6
MGJ3T24150505MC	15	120	1.8	5	120	0.6	5	120	0.6

SELECTION GUIDE (Continued)

Order Code	Output 1				Output 2				Output 3			
	Load Regulation (Typ)	Load Regulation (Max)	Ripple & Noise (Typ) ²	Ripple & Noise (Max) ²	Load Regulation (Typ)	Load Regulation (Max)	Ripple & Noise (Typ) ²	Ripple & Noise (Max) ²	Load Regulation (Typ)	Load Regulation (Max)	Ripple & Noise (Typ) ²	Ripple & Noise (Max) ²
	%	%	mVp-p	mVp-p	%	%	mVp-p	mVp-p	%	%	mVp-p	mVp-p
MGJ3T05150505MC	3	10	69	200	3	10	49	75	3	10	49	75
MGJ3T12150505MC	3	10	85	200	3	10	54	75	3	10	54	75
MGJ3T24150505MC	3	10	83	200	3	10	52	75	3	10	52	75

SELECTION GUIDE (Continued)

Order Code	Nominal Input Voltage	Input Current at Rated Load	Efficiency (Min)	Efficiency (Typ)	Isolation Capacitance	MTTF ¹
	V	mA	%		pF	kHrs
MGJ3T05150505MC	5	760	75	78.5	15	
MGJ3T12150505MC	12	310	78	82	15	
MGJ3T24150505MC	24	155	77	81	15	

z



For full details go to www.murata-ps.com/rohs

1. Calculated using MIL-HDBK-217 FN2 calculation model with nominal input voltage at full load.
 2. See ripple & noise test method.
 All specifications typical at T_a=25°C, nominal input voltage and rated output current unless otherwise specified.

INPUT CHARACTERISTICS					
Parameter	Conditions	Min.	Typ.	Max.	Units
Voltage range	5V input types	4.5	5	9	V
	12V input types	9	12	18	
	24V input types	18	24	36	
Under voltage lock out	Turn on threshold MGJ3T05		4.1		V
	Turn off threshold MGJ3T05		3.0		
	Turn on threshold MGJ3T12		8.1		
	Turn off threshold MGJ3T12		7.5		
	Turn on threshold MGJ3T24		16.7		
	Turn off threshold MGJ3T24		16.1		
Input ripple current	5V input types		18		mA p-p
	12V input types		12		
	24V input types		9		

OUTPUT CHARACTERISTICS					
Parameter	Conditions	Min.	Typ.	Max.	Units
Minimal load to meet datasheet specification		40			%
Voltage set point accuracy	All output types		±4		%
Line regulation	Low line to high line			2	%
Transient response	Peak deviation (50-100% & 100-50% swing)		1.2		%V _{out}
	Settling time		0.25		ms

ISOLATION CHARACTERISTICS					
Parameter	Conditions	Min.	Typ.	Max.	Units
Isolation test voltage	Flash tested for 1 second	5200			VDC
Resistance	Viso = 1kVDC	100			GΩ

GENERAL CHARACTERISTICS					
Parameter	Conditions	Min.	Typ.	Max.	Units
Switching frequency			100		kHz

TEMPERATURE CHARACTERISTICS					
Parameter	Conditions	Min.	Typ.	Max.	Units
Operation		-40		105	°C
Storage		-50		125	
Product temperature above ambient	100% Load, Nom V _{in} , Still Air		18		

ABSOLUTE MAXIMUM RATINGS					
Short-circuit protection			Continuous		
Input voltage, MGJ3 5V input types			12V		
Input voltage, MGJ3 12V input types			20V		
Input voltage, MGJ3 24V input types			40V		

RoHS COMPLIANCE, MSL AND PSL INFORMATION	
	<p>This series is compatible with RoHS soldering systems with a peak reflow solder temperature of 245°C as per J-STD-020D.1. The pin termination finish on this product series is Gold with Nickel Pre-plate. The series is backward compatible with Sn/Pb soldering systems. The series has a Moisture Sensitivity Level (MSL) 1.</p>

APPLICATION NOTES

Start-up times

Typical start up times for this series, with no additional output capacitance are:

Part No.	Start-up times
	ms
MGJ3T05150505MC	15
MGJ3T12150505MC	15
MGJ3T24150505MC	15

Output capacitance must not exceed:

Output Voltage	Maximum output capacitance
V	µF
15	120
5	220

Disable/Frequency synchronisation

		Min	Typ	Max	Units
Disable/Synch	Pull Down Current		0.5		mA
	Input High	2		5	V
	Input Low	0		0.8	V
Synchronisation	Frequency Range	90	100	110	kHz
	Duty Cycle	25		75	%

Output configurations for power switches

Terminal	IGBT	SIC	MOSFET
(P10) 15V Output	+15V 0.12A	+20V 0.12A	+15V 0.15A
(P9) 15V Return 5VA Output	0V	No connection	0V
(P7) 5VA Return 5VB Output	No connection	0V	-5V 0.15A
(P8) 5VB Return	-10V 0.12A	-5V 0.12A	No connection

TECHNICAL NOTES

ISOLATION VOLTAGE

'Hi Pot Test', 'Flash Tested', 'Withstand Voltage', 'Proof Voltage', 'Dielectric Withstand Voltage' & 'Isolation Test Voltage' are all terms that relate to the same thing, a test voltage, applied for a specified time, across a component designed to provide electrical isolation, to verify the integrity of that isolation.

Murata Power Solutions MGJ3 series of DC/DC converters are all 100% production tested at their stated isolation voltage. This is 5.2kVDC for 1 second.

A question commonly asked is, "What is the continuous voltage that can be applied across the part in normal operation?"

The MGJ3 series is pending recognition by Underwriters Laboratory for various voltages, please see safety approval section below.

REPEATED HIGH-VOLTAGE ISOLATION TESTING

It is well known that repeated high-voltage isolation testing of a barrier component can actually degrade isolation capability, to a lesser or greater degree depending on materials, construction and environment. We therefore strongly advise against repeated high voltage isolation testing, but if it is absolutely required, that the voltage be reduced by 20% from specified test voltage.

SAFETY APPROVAL

ANSI/AAMI ES60601-1

The MGJ3 series is pending recognition ANSI/AAMI ES60601-1 and provides 1 MOOP (means of operator protection) based upon a working voltage of 250 Vrms max., between Primary and Secondary.

UL 60950

The MGJ3 series is pending recognition by Underwriters Laboratory (UL) to UL 60950 for reinforced insulation to a working voltage of 250Vrms.

CHARACTERISATION TEST METHODS

Ripple & Noise Characterisation Method

Ripple and noise measurements are performed with the following test configuration.

C1	1µF X7R multilayer ceramic capacitor, voltage rating to be a minimum of 3 times the output voltage of the DC/DC converter
C2	10µF tantalum capacitor, voltage rating to be a minimum of 1.5 times the output voltage of the DC/DC converter with an ESR of less than 100mΩ at 100 kHz
C3	100nF multilayer ceramic capacitor, general purpose
R1	450Ω resistor, carbon film, ±1% tolerance
R2	50Ω BNC termination
T1	3T of the coax cable through a ferrite toroid
RLOAD	Resistive load to the maximum power rating of the DC/DC converter. Connections should be made via twisted wires

Measured values are multiplied by 10 to obtain the specified values.

Differential Mode Noise Test Schematic

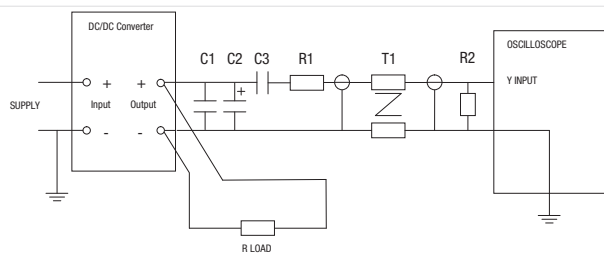

EFFICIENCY VS LOAD

MGJ3T05150505MC

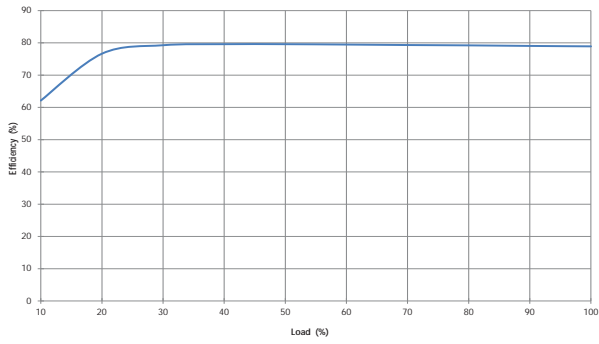

MGJ3T12150505MC

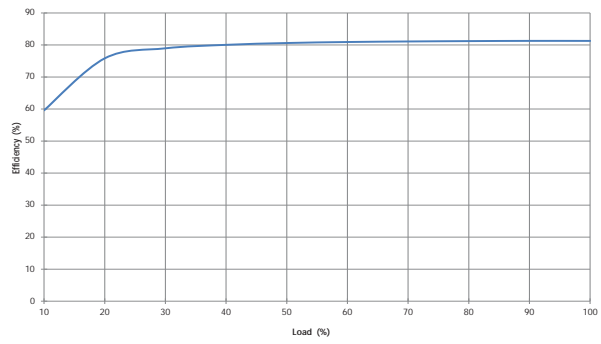

MGJ3T24150505MC

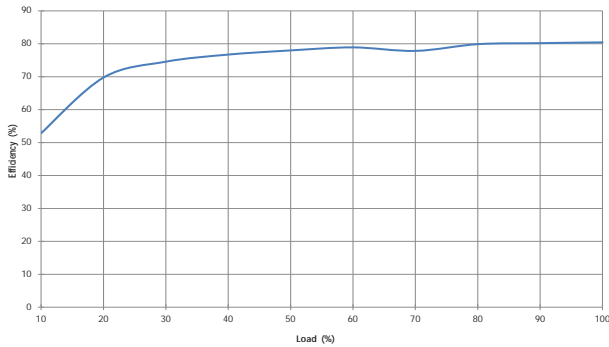

EMC FILTERING AND SPECTRA

FILTERING

The following filter circuit and filter table shows the input filters typically required to meet EN55022 Quasi-Peak Curve A or B.

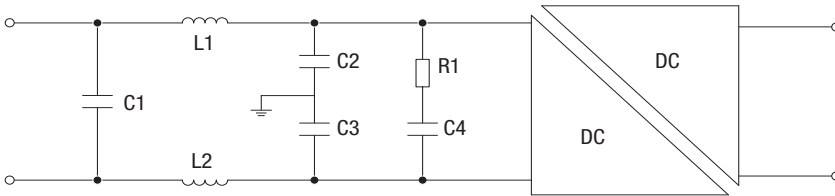

C1, C2 & C3 Polyester or ceramic capacitor

C4 Electrolytic capacitor (note R1 could be omitted if C4 has ESR \geq R1)

TO MEET CURVE B							
Part Number	C1	L1	L2	C2	C3	R1	C4
MGJ3T05150505MC	1.5 μ F	476R8SC	10nF	10nF	10nF	500m Ω	220 μ F
MGJ3T12150505MC	1.5 μ F	476R8SC	10nF	10nF	10nF	500m Ω	220 μ F
MGJ3T24150505MC	1.5 μ F	476R8SC	10nF	10nF	10nF	500m Ω	220 μ F

MGJ3T05150505MC

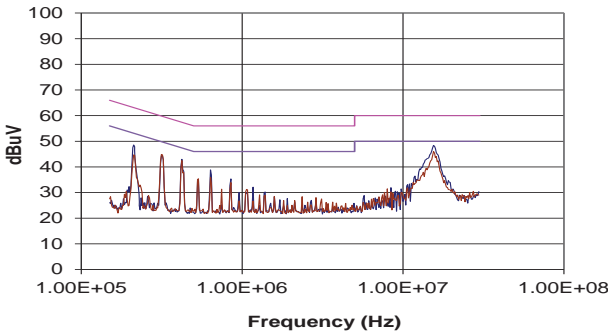

MGJ3T12150505MC

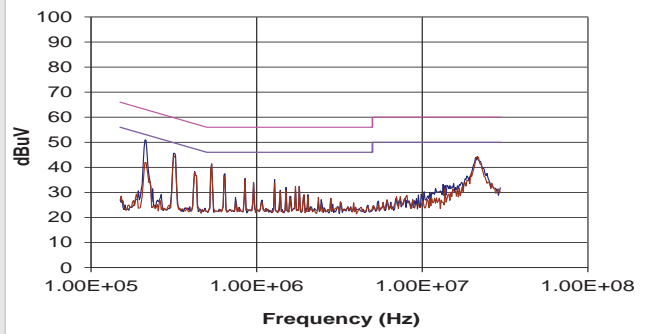

MGJ3T24150505MC

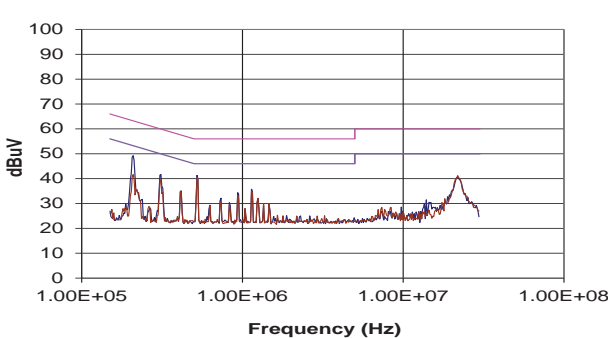

PACKAGE SPECIFICATIONS

MECHANICAL DIMENSIONS

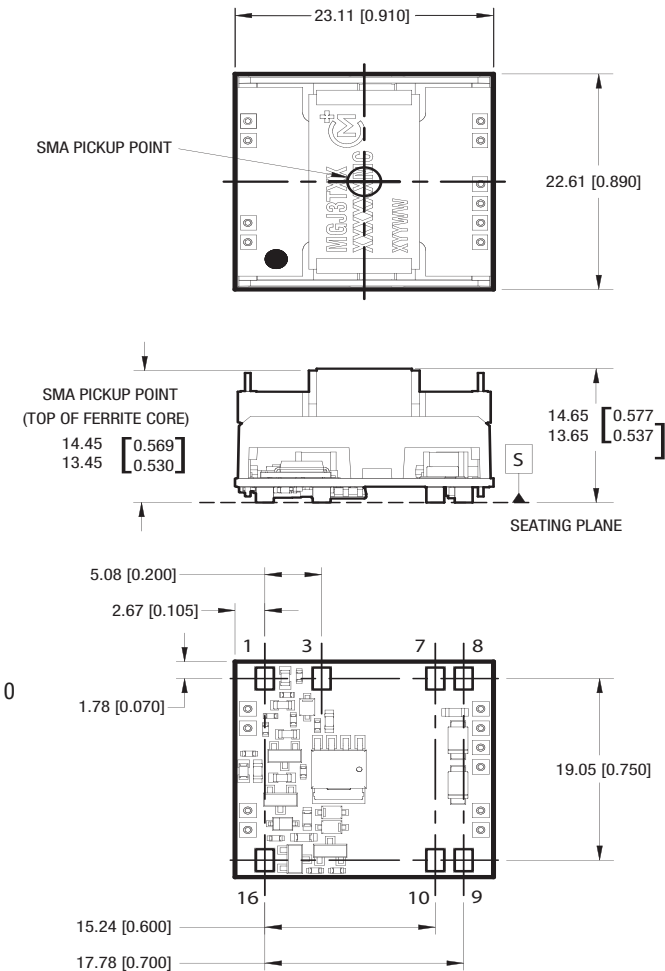

All dimensions in mm (inches). Controlling dimensions is mm.
Tolerance (unless otherwise stated) ±0.25 (0.010).

Weight: 10.70 g

PIN CONNECTIONS

Pin	Function
1	-Vin
3	Dis/Sync
7	5VA RTN
	5VB
8	5VB RTN
9	15V RTN
	5VA
10	15 Vout
16	+Vin

RECOMMENDED FOOTPRINT DETAILS

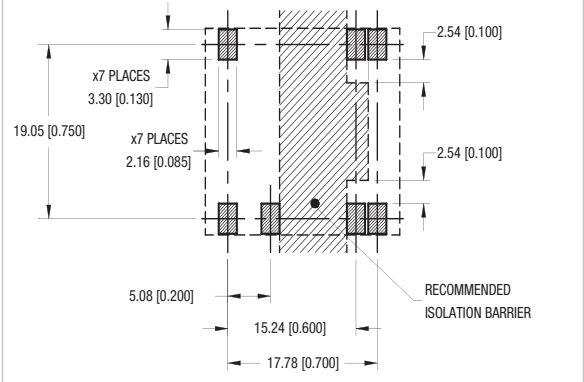

TAPE & REEL SPECIFICATIONS

REEL OUTLINE DIMENSIONS

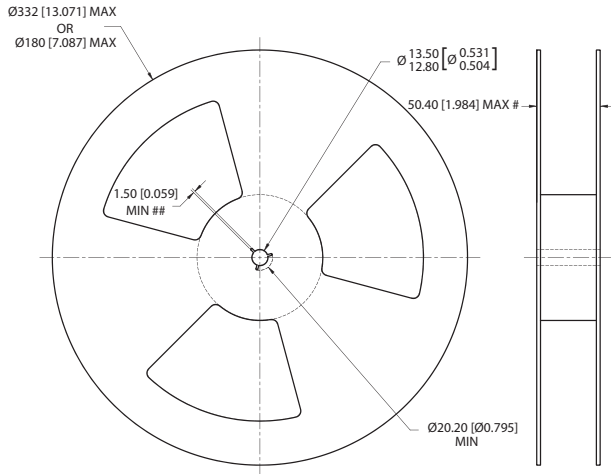

Tape & Reel specifications shall conform with current EIA-481 standard
 Unless otherwise stated all dimensions in mm(inches)
 Controlling dimension is mm
 # Measured at hub
 ## Six equi-spaced slots on 180mm/7" reel

TAPE OUTLINE DIMENSIONS

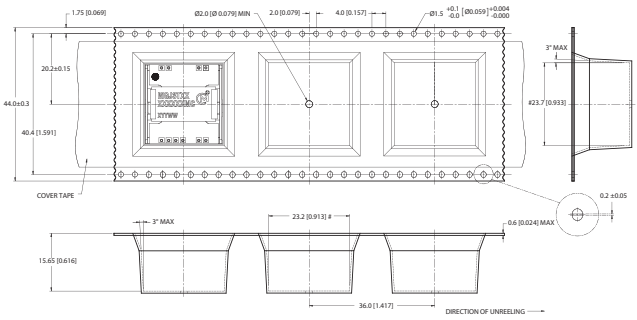

Tape & Reel specifications shall conform with current EIA-481 standard
 Unless otherwise stated all dimensions in mm(inches) ±0.1mm (±0.004 Inches)
 Controlling dimension is mm
 Components shall be orientated within the carrier tape as indicated
 # Measured on a plane 0.3mm above the bottom pocket

REEL PACKAGING DETAILS

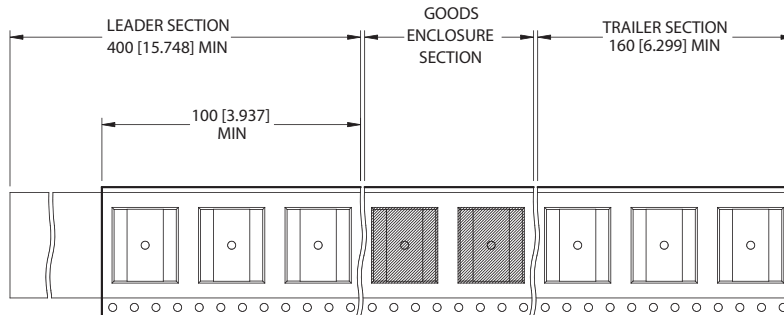

Reel Quantity: 7" - 23 or 13" - 92

Murata Power Solutions, Inc.
 11 Cabot Boulevard, Mansfield, MA 02048-1151 U.S.A.
 ISO 9001 and 14001 REGISTERED



This product is subject to the following **operating requirements** and the **Life and Safety Critical Application Sales Policy**:
 Refer to: <http://www.murata-ps.com/requirements/>

Murata Power Solutions, Inc. makes no representation that the use of its products in the circuits described herein, or the use of other technical information contained herein, will not infringe upon existing or future patent rights. The descriptions contained herein do not imply the granting of licenses to make, use, or sell equipment constructed in accordance therewith. Specifications are subject to change without notice.
 © 2014 Murata Power Solutions, Inc.