

VA-0.5W Series



0.5W Unregulated Single output

Features

- 4 Pin SIL / 8 Pin DIL Package
- 1000 VDC Isolation
- Up to 3000 VDC Isolation
- Low Ripple and Noise
- Efficiency up to 83%
- -40 ~ 85°C Operation Temperature Range
- Non-Conductive Black Plastic Case
- EMI Complies With EN55022 Class B



The VA series is a family of cost effective 0.5W single output DC-DC converters. These converters achieve low cost and ultra-miniature SIP 4 pin or DIP 8 pin size. Devices are encapsulated using flame retardant resin. The models operate from input voltage of 3.3, 5, 12, 15, 24, 48 Vdc with output voltage of 3.3, 5, 7.2, 9, 12, 15, 18, 24 Vdc. High performance features include 1000Vdc~3000Vdc input/output isolation, high efficiency operation and output voltage accuracy of $\pm 3\%$ maximum. Standard features include an input range of $\pm 10\%$ tolerance and low output noise and ripple.

All specifications typical at Ta=25°C, nominal input voltage and full load unless otherwise specified

OUTPUT SPECIFICATIONS		Case Material		Non-conductive Black Plastic(UL94V-0 rated)	
Voltage accuracy	$\pm 3\%$	Pin Material			
Line regulation	$\pm 1.2\%$ / Per 1% Vin Change	SIP Case	0.5mm Alloy42 Solder-coated		
Load regulation	(From 20% to 100% Load) $\pm 10\%$ (Output 3.3V Model) $\pm 20\%$	DIP Case	$\Phi 0.5\text{mm}$ Brass Solder-coated		
Ripple & noise (20 MHz bandwidth)(1)	100mV pk-pk	Potting Material	Epoxy (UL94V-0 rated)		
Temperature coefficient	$\pm 0.02\%/^{\circ}\text{C}$	Weight	(SIP/1.5g) (DIP/1.8g)		
Capacitor load(2)	See table	Dimensions	SIP Case 0.46"x0.24"x0.40" DIP Case 0.50"x0.40"x0.27"		
INPUT SPECIFICATIONS		ABSOLUTE MAXIMUM RATINGS(4)			
Voltage Range	$\pm 10\%$	These are stress ratings. Exposure of devices to any of these conditions may adversely affect long-term reliability.			
Max. Input Current	See table	Input Surge Voltage(100mS)			
No-Load Input Current	See table	3.3 Models	6 Vdc ,max.		
Input Filter	Capacitors	5 Models	7 Vdc ,max.		
Input Reflected Ripple Current(3)	20mA pk-pk	12 Models	15 Vdc ,max.		
		15 Models	18 Vdc ,max.		
		24 Models	28 Vdc ,max.		
		48 Models(for SIP)	54 Vdc ,max.		
GENERAL SPECIFICATIONS		Soldering Temperature		260°C ,max.	
Efficiency	See table	(1.5mm from case 10 sec. max.)			
I/O Isolation Voltage(60 sec)	Input/Output 1000~3000Vdc	EMC SPECIFICATIONS			
I/O Isolation Capacitance	60 pF Typ.	Radiated Emissions	EN55022	CLASS B	
I/O Isolation Resistance	1000M Ohm	Conducted Emissions (6)	EN55022	CLASS B	
Switching Frequency	Variable 80kHz	ESD	IEC 61000-4-2	Perf. Criteria A	
Humidity	95% rel H	RS	IEC 61000-4-3	Perf. Criteria A	
Reliability Calculated MTBF(MIL-HDBK-217 F)	>1.121Mhrs	EFT (7)	IEC 61000-4-4	Perf. Criteria A	
Safety Standard : (designed to meet)	IEC 60950-1	Surge (7)	IEC 61000-4-5	Perf. Criteria A	
		CS	IEC 61000-4-6	Perf. Criteria A	
		PFMF	IEC 61000-4-8	Perf. Criteria A	
ENVIRONMENT SPECIFICATIONS					
Operating Temperature	-40°C~85°C(See Derating Curve)				
Maximum Case Temperature	100°C				
Storage Temperature	-40°C~125°C				
Cooling	Nature Convection				

The information and specifications contained in this data sheet are believed to be correct at time of publication. However, MOTIEN Technologies accepts no responsibility for consequences arising from printing errors or inaccuracies. Specifications are subject to change without notice. No rights under any patent accompany the sale of any such product(s) or information contained herein.

VA - 0.5W Unregulated Single output

PART NUMBER STRUCTURE

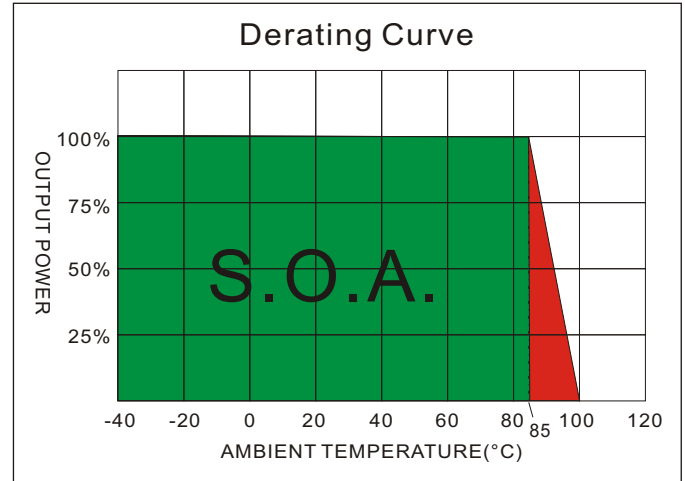
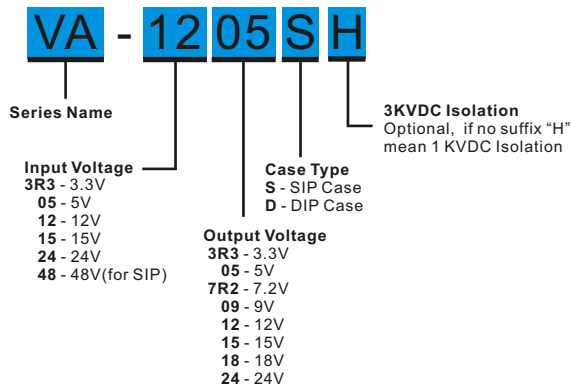

MODEL SELECTION GUIDE

MODEL NUMBER	INPUT	INPUT Current		OUTPUT	OUTPUT Current	EFFICIENCY @FL(%)	Capacitor Load(uF)
	Voltage Range (Vdc)	No-Load (mA)	Full Load (mA)	Voltage (Vdc)	Full load (mA)		
VA-3R3R3S	3.3	20	205	3.3	152	76	100
VA-3R305S	3.3	25	216	5	100	70	100
VA-3R37R2S	3.3	25	216	7.2	69	70	100
VA-3R309S	3.3	25	216	9	56	70	100
VA-3R312S	3.3	25	201	12	42	72	100
VA-3R315S	3.3	25	208	15	33	73	100
VA-3R318S	3.3	25	208	18	28	73	100
VA-3R324S	3.3	25	208	24	21	73	100
VA-053R3S	5	20	132	3.3	151.5	76	100
VA-0505S	5	13	121	5	100	83	100
VA-057R2S	5	15	134	7.2	69.44	75	100
VA-0509S	5	15	128	9	55.55	78	100
VA-0512S	5	18	127	12	41.67	79	100
VA-0515S	5	22	130	15	33.33	77	100
VA-0518S	5	20	127	18	27.77	79	100
VA-0524S	5	25	134	24	20.83	75	100
VA-123R3S	12	15	58	3.3	151.5	72	100
VA-1205S	12	10	54	9	100	78	100
VA-127R2S	12	15	57	7.2	69.44	73	100
VA-1209S	12	15	57	9	55.56	73	100
VA-1212S	12	20	58	12	41.67	72	100
VA-1215S	12	20	61	15	33.33	69	100
VA-1218S	12	15	61	18	27.77	68	100
VA-1224S	12	15	59	24	20.83	71	100
VA-153R3S	15	10	44	3.3	151.5	75	100
VA-1505S	15	8	43	5	100	78	100
VA-157R2S	15	12	44	7.2	69.44	75	100
VA-1509S	15	12	44	9	55.55	75	100
VA-1512S	15	10	44	12	41.67	77	100
VA-1515S	15	15	48	15	33.33	70	100
VA-1518S	15	12	51	18	27.77	66	100
VA-1524S	15	10	51	24	20.83	66	100

Suffix "H" means 3 KVdc isolation

The models listed above is just for standard type. If you need the special specification product, please contact our service member by telephone presented in shortform cover or e-mail to : sales@motien.com.tw

VA - 0.5W Unregulated Single output

MODEL NUMBER	INPUT	INPUT Current		OUTPUT	OUTPUT Current	EFFICIENCY @FL(%)	Capacitor Load(μF)
	Voltage Range (Vdc)	No-Load (mA)	Full Load (mA)	Voltage (Vdc)	Full load (mA)		
VA-243R3S	24	8	31	3.3	151.5	69	100
VA-2405S	24	8	29	5	100	73	100
VA-247R2S	24	10	30	7.2	69.44	70	100
VA-2409S	24	10	30	9	55.55	71	100
VA-2412S	24	8	30	12	41.67	71	100
VA-2415S	24	10	29	15	33.33	73	100
VA-2418S	24	10	29	18	27.77	73	100
VA-2424S	24	10	29	24	20.83	72	100
VA-483R3S	48	6	17	3.3	151.5	60	100
VA-4805S	48	6	16	5	100	66	100
VA-487R2S	48	6	17	7.2	69.44	60	100
VA-4809S	48	6	17	9	55.55	62	100
VA-4812S	48	6	17	12	41.67	64	100
VA-4815S	48	6	17	15	33.33	62	100
VA-4818S	48	6	17	18	27.77	62	100
VA-4824S	48	10	18	24	20.83	61	100
VA-3R33R3D	3.3	20	205	3.3	152	76	100
VA-3R305D	3.3	25	216	5	100	70	100
VA-3R37R2D	3.3	25	216	7.2	69	70	100
VA-3R309D	3.3	25	216	9	56	70	100
VA-3R312D	3.3	25	201	12	42	72	100
VA-3R315D	3.3	25	208	15	33	73	100
VA-3R318D	3.3	25	208	18	28	73	100
VA-3R324D	3.3	25	208	24	21	73	100
VA-053R3D	5	16	132	3.3	151.5	76	100
VA-0505D	5	15	124	5	100	81	100
VA-057R2D	5	15	134	7.2	69.44	75	100
VA-0509D	5	15	128	9	55.55	78	100
VA-0512D	5	18	127	12	41.67	79	100
VA-0515D	5	22	130	15	33.33	77	100
VA-0518D	5	20	127	18	27.77	79	100
VA-0524D	5	25	134	24	20.83	75	100
VA-123R3D	12	15	58	3.3	151.5	73	100
VA-1205D	12	12	54	5	100	78	100
VA-127R2D	12	15	57	7.2	69.44	73	100
VA-1209D	12	15	58	9	55.56	73	100
VA-1212D	12	20	58	12	41.67	72	100
VA-1215D	12	20	61	15	33.33	69	100
VA-1218D	12	15	61	18	27.77	68	100
VA-1224D	12	15	59	24	20.83	71	100
VA-153R3D	15	10	44	3.3	151.5	75	100
VA-1505D	15	8	43	5	100	78	100
VA-157R2D	15	12	44	7.2	69.44	75	100
VA-1509D	15	12	44	9	55.55	75	100
VA-1512D	15	10	44	12	41.67	77	100
VA-1515D	15	15	48	15	33.33	70	100
VA-1518D	15	12	51	18	27.77	66	100
VA-1524D	15	10	51	24	20.83	66	100

Suffix "H" means 3 KVdc isolation

The models listed above is just for standard type. If you need the special specification product, please contact our service member by telephone presented in shortform cover or e-mail to : sales@motien.com.tw

VA - 0.5W Unregulated Single output

MODEL NUMBER	INPUT	INPUT Current		OUTPUT	OUTPUT Current	EFFICIENCY @FL(%)	Capacitor Load(μF)
	Voltage Range (Vdc)	No-Load (mA)	Full Load (mA)	Voltage (Vdc)	Full load (mA)		
VA-243R3D	24	8	31	3.3	151.5	69	100
VA-2405D	24	10	29	5	100	74	100
VA-247R2D	24	10	31	7.2	69.44	69	100
VA-2409D	24	10	30	9	55.55	71	100
VA-2412D	24	10	31	12	41.67	69	100
VA-2415D	24	9	31	15	33.33	69	100
VA-2418D	24	10	29	18	27.77	73	100
VA-2424D	24	10	29	24	20.83	72	100

Suffix "H" means 3 KVdc isolation

TEST CONFIGURATIONS

Input Reflected Ripple Current Test Step

Input reflected ripple current is measured through a source inductor L_{in} (12μH) and a source capacitor C_{in} (47μF, ESR<1.0Ω at 100KHz) at nominal input and full load.

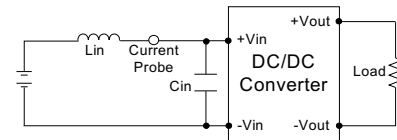

Output Ripple & Noise Measurement Test

The Scope measurement bandwidth is 20MHz .

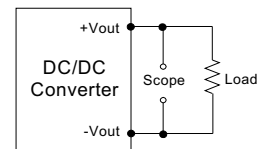

EMI Filter

Input filter components (C_1 , L , C_2 , C_3) are used to help meet conducted emissions requirement for the module.

These components should be mounted as close as possible to the module; and all leads should be minimized to decrease radiated noise.

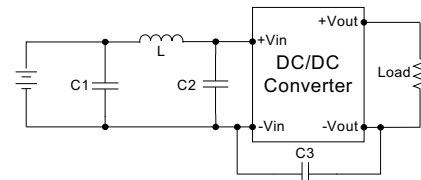

	C1	L	C2	C3
VA-3R3XXXXX	1210, 2.2μF/100V	18μH		
VA-05XXXXX	1210, 2.2μF/100V	18μH		
VA-12XXXXX	1210, 2.2μF/100V	18μH		
VA-15XXXXX	1210, 2.2μF/100V	18μH		
VA-24XXXXX	1210, 2.2μF/100V	18μH	1210, 2.2μF/100V	1206, 470pF/2KV
VA-48XXXXX	Electrolytic capacitor, 10μF/100V	18μH	1210, 2.2μF/100V	1206, 470pF/2KV

NOTE

1. Ripple/Noise measured with 20MHz bandwidth.
2. Tested by minimal V_{in} and constant resistive load.
3. Measured Input reflected ripple current with a simulated source inductance of 12μH.
4. Exceeding the absolute ratings of the unit could cause damage. It is not allowed for continuous operating.
5. Operation under no-load conditions will not damage these devices, however they may not meet all listed specifications.
6. Input filter components are required to help meet conducted emission class B, which application refer to the EMI Filter of design & feature configuration.
7. An external filter capacitor is required if the module has to meet IEC61000-4-4 and IEC61000-4-5.
The filter capacitor Motien suggest: Nippon - chemi - con KY series, 470μF/100V.

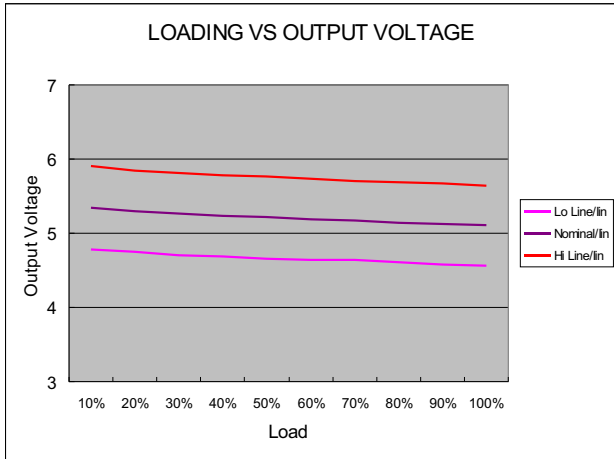

05 Models

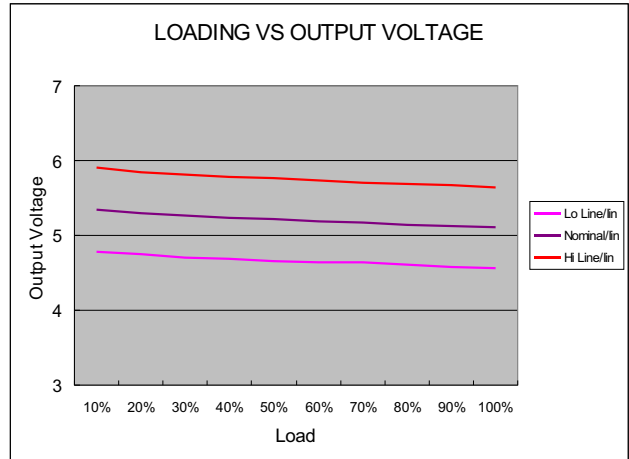

12 Models

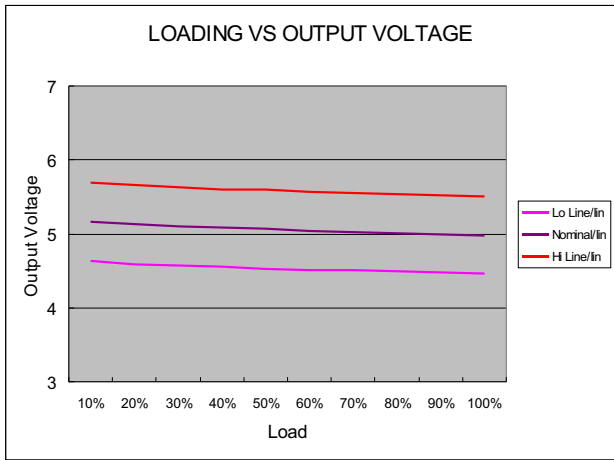

24 Models

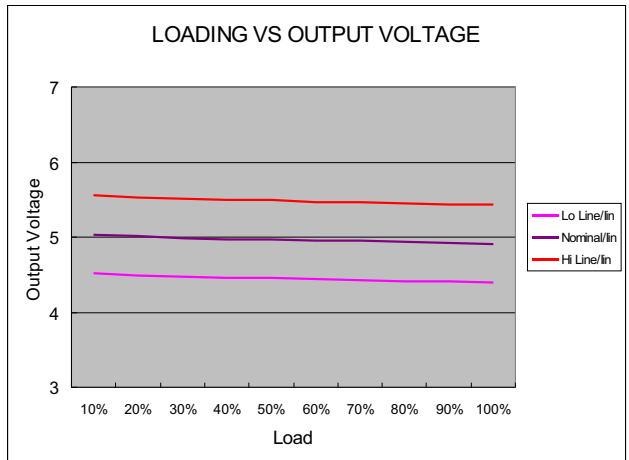

48 Models

MECHANICAL SPECIFICATIONS

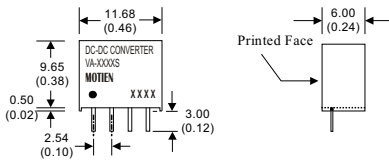

* The thickness of 48V input voltage model is 7.50(0.29)

4 Pin SIL Package

- Notes : All dimensions are typical in millimeters (inches).
1. Pin diameter: 0.5±0.05 (0.02±0.002)
 2. Pin pitch and length tolerance: ±0.35 (±0.014)
 3. Case Tolerance: ±0.5 (±0.02)

PIN CONNECTIONS	
PIN NUMBER	SINGLE
1	-V Input
2	+V Input
3	-V Output
4	+V Output

(The Pin Connection of high isolation one is the same with normal one.)

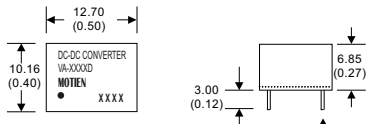
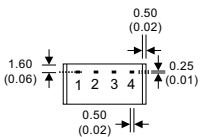

8 Pin DIL Package

- Notes : All dimensions are typical in millimeters (inches).
1. Pin diameter: 0.5±0.05 (0.02±0.002)
 2. Pin pitch and length tolerance: ±0.35 (±0.014)
 3. Case Tolerance: ±0.5 (±0.02)

PIN CONNECTIONS	
PIN NUMBER	SINGLE
1	-V Input
4	+V Input
5	+V Output
7	-V Output

(The Pin Connection of high isolation one is the same with normal one.)