

DC/DC Converter
 AC/DC Inverters
 Delay-Lines
 Pulsetransformers
 Burst & Surge Filters
 Harmonic Filters
 Switching Power Supplies

Am Malfinger Steig 13
 86920 Denklingen/Obb.
 Germany
 Tel.: 08243-9693-0
 Fax: 08243-9693-33
 www.floeth-electronic.com



Stand: 12/07

Wide input range 1:2
 Case style: DIP24

COMMERCIAL DC/DC Converters PWM - regulated

2,2 Watt
 Series: CW2

Electrical specifications:

Input voltage: wide 1:2
 Output voltage accuracy: +/- 1% max.
 Line regulation: +/- 0,2%
 Load regulation: +/- 0,5% (20% to 100% Load)
 Efficiency: up to 84%
 Output Ripple & Noise: 50mVp-p max.
 Short circuit protection: continuous

Operating temperature: -40°C to +85°C
 Isolation voltage: min. 1000V DC
 Optional Part-No.: /H2 min. 2000V DC
 Part-No.: /H3 min. 3000V DC
 (/H2; /H3 only available with Pinning "A" and "C")
 Case material: black plastic
 Optional Part-No.: /M metal case
 Part-No.: /SMD SMD-package
 (/M; /SMD Isolation voltage max. 2kVDC)

CAUTION: NO INPUT POLARITY CHANGE ALLOWED!

Part - No. Single Output	Input Voltage DC	Output Voltage DC	Output current	Part - No. Dual Output	Input Voltage DC	Output Voltage DC	Output current
CW2-xx03,3	5V (4,5-9V) 12V (9-18V) 24V (18-36V) 48V (36-72V)	3,3V	600mA	CW2-xx03,3D	5V (4,5-9V) 12V (9-18V) 24V (18-36V) 48V (36-72V)	±3,3V	±300mA
CW2-xx05		5V	440mA	CW2-xx05D		± 5V	±220mA
CW2-xx09		9V	244mA	CW2-xx09D		± 9V	±122mA
CW2-xx12		12V	183mA	CW2-xx12D		±12V	± 91mA
CW2-xx15		15V	146mA	CW2-xx15D		±15V	± 73mA

Any other output voltages available

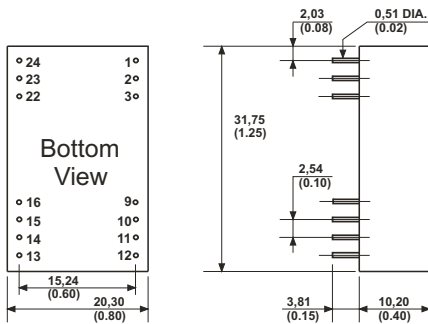

PIN	SINGLE	DUAL	SINGLE A	DUAL A	SINGLE C	DUAL C
1	+Vin	+Vin			+Vin	+Vin
2	NP	-Vout	-Vin	-Vin	+Vin	+Vin
3	NP	COM	-Vin	-Vin		
9			NC	COM		
10	-Vout	COM			NC	COM
11	+Vout	+Vout	NC	-Vout	NC	COM
12	-Vin	-Vin			-Vout	NC
13	-Vin	-Vin			+Vout	-Vout
14	+Vout	+Vout	+Vout	+Vout		
15	-Vout	COM			NC	+Vout
16			-Vout	COM		
22	NP	COM	+Vin	+Vin		
23	NP	-Vout	+Vin	+Vin	-Vin	-Vin
24	+Vin	+Vin			-Vin	-Vin

SMD-Pinning Part-No.: /SMD

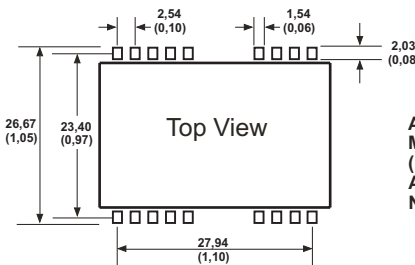
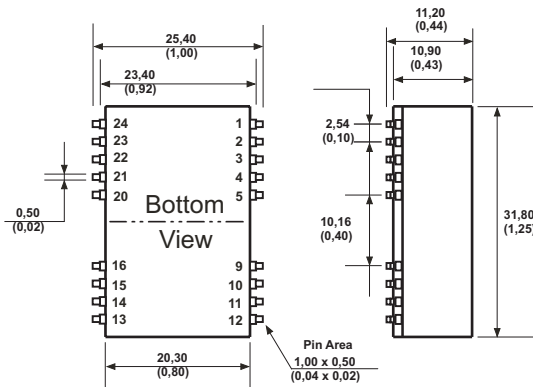

Add "A" to the end of Partnumber.
 For example CW2-2405A/H3 2,2Watt.

ALL DIMENSIONS IN MM (INCHES)
 MILLIMETERS +/- 0,25mm
 (INCHES +/-0,01")
 All pins on a 2,54mm pitch
 Note: NP = No pin; NC = No connection;
 Dot denotes pin 1

Specification may be changed without notice
 please contact office for verification

We can offer EMC - Filter
 according to EN55011/22 Class B.

DC/DC Converter
 AC/DC Inverters
 Delay-Lines
 Pulsetransformers
 Burst & Surge Filters
 Harmonic Filters
 Switching Power Supplies

Am Malfinger Steig 13
 86920 Denklingen/Obb.
 Germany
 Tel.: 08243-9693-0
 Fax: 08243-9693-33
 www.floeth-electronic.com



Stand: 12/07

Wide input range 1:2
 Case style: DIP24

COMMERCIAL DC/DC Converters PWM - regulated

3 Watt
 Series: CW2

Electrical specifications:

Input voltage: wide 1:2
 Output voltage accuracy: +/- 1% max.
 Line regulation: +/- 0,2%
 Load regulation: +/- 0,5% (20% to 100% Load)
 Efficiency: up to 84%
 Output Ripple & Noise: 50mVp-p max.
 Short circuit protection: continuous
 Operating temperature Uin = 5V: -40°C to +80°C
 Uin = 12V; 24V; 48V: -40°C to +85°C

Isolation voltage: min. 1000V DC
 Optional Part-No.: /H2 min. 2000V DC
 Part-No.: /H3 min. 3000V DC
 Part-No.: /H4 min. 4000V DC
 Part-No.: /H5 min. 5000V DC
 Part-No.: /H6 min. 6000V DC
 (/H2 - /H6 only available with Pinning "A" and "C")

Case material: black plastic
 Optional Part-No.: /M metal case
 Part-No.: /SMD SMD-package
 (/M; /SMD Isolation voltage max. 2kVDC)

CAUTION: NO INPUT POLARITY CHANGE ALLOWED!

Part - No. Single Output	Input Voltage DC	Output Voltage DC	Output current	Part - No. Dual Output	Input Voltage DC	Output Voltage DC	Output current
CW2-xx03,3	5V (4,5-9V) 12V (9-18V) 24V (18-36V) 48V (36-72V)	3,3V	900mA	CW2-xx05D CW2-xx09D CW2-xx12D CW2-xx15D	5V (4,5-9V) 12V (9-18V) 24V (18-36V) 48V (36-72V)	± 5V	±300mA
CW2-xx05		5V	600mA			± 9V	±165mA
CW2-xx09		9V	330mA			± 12V	±125mA
CW2-xx12		12V	250mA			±15V	±100mA
CW2-xx15		15V	200mA				

Any other output voltages available

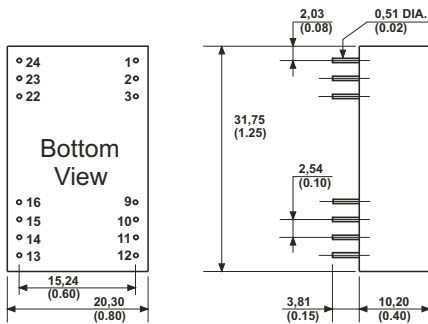

PIN CONNECTION:						
PIN	SINGLE	DUAL	SINGLE A	DUAL A	SINGLE C	DUAL C
1	+Vin	+Vin			+Vin	+Vin
2	NP	-Vout	-Vin	-Vin	+Vin	+Vin
3	NP	COM	-Vin	-Vin		
9			NC	COM		
10	-Vout	COM			NC	COM
11	+Vout	+Vout	NC	-Vout	NC	COM
12	-Vin	-Vin			-Vout	NC
13	-Vin	-Vin			+Vout	-Vout
14	+Vout	+Vout	+Vout	+Vout		
15	-Vout	COM			NC	+Vout
16			-Vout	COM		
22	NP	COM	+Vin	+Vin		
23	NP	-Vout	+Vin	+Vin	-Vin	-Vin
24	+Vin	+Vin			-Vin	-Vin

SMD-Pinning Part-No.: /SMD

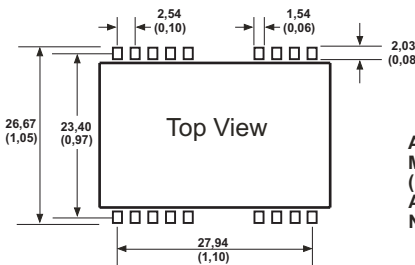
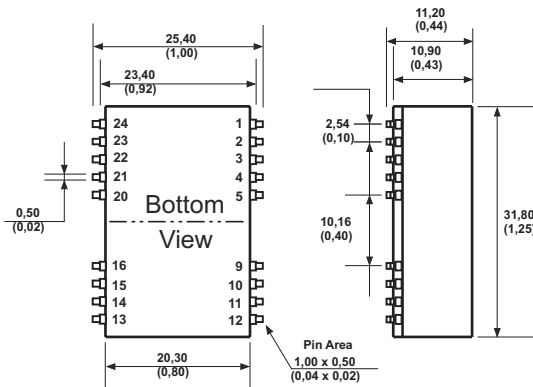

Add "A" to the end of Partnumber.
 For example CW2-2405A/H3 3Watt.

ALL DIMENSIONS IN MM (INCHES)
 MILLIMETERS +/- 0,25mm
 (INCHES +/- 0,01")
 All pins on a 2,54mm pitch
 Note: NP = No pin; NC = No connection;
 Dot denotes pin 1

Specification may be changed without notice
 please contact office for verification

We can offer EMC - Filter
 according to EN55011/22 Class B.

DC/DC Converter
 AC/DC Inverters
 Delay-Lines
 Pulsetransformers
 Burst & Surge Filters
 Harmonic Filters
 Switching Power Supplies

Am Malfinger Steig 13
 86920 Denklingen/Obb.
 Germany
 Tel.: 08243-9693-0
 Fax: 08243-9693-33
 www.floeth-electronic.com



Stand: 12/07

Wide input range 1:2
 Case style: DIP24

COMMERCIAL DC/DC Converters PWM - regulated

5 Watt
 Series: CW2

Electrical specifications:

Input voltage: wide 1:2
 Output voltage accuracy: +/- 1% max.
 Line regulation: +/- 0,2%
 Load regulation: +/- 0,5% (20% to 100% Load)
 Efficiency: up to 84%
 Output Ripple & Noise: 50mVp-p max.
 Short circuit protection: continuous
 Operating temperature: -40°C to +75°C

Isolation voltage: min. 1000V DC
 Optional Part-No.: /H2 min. 2000V DC
 Part-No.: /H3 min. 3000V DC
 Part-No.: /H4 min. 4000V DC
 Part-No.: /H5 min. 5000V DC
 Part-No.: /H6 min. 6000V DC
 (/H2 - /H6 only available with Pinning "A" and "C")

Case material: black plastic
 Optional Part-No.: /M metal case
 Part-No.: /SMD SMD-package
 (/M; /SMD Isolation voltage max. 2kVDC)

CAUTION: NO INPUT POLARITY CHANGE ALLOWED!

Part - No. Single Output	Input Voltage DC	Output Voltage DC	Output current	Part - No. Dual Output	Input Voltage DC	Output Voltage DC	Output current
CW2-xx03,3	12V (9-18V) 24V (18-36V) 48V (36-72V)	3,3V	1200mA	CW2-xx05D CW2-xx09D CW2-xx12D CW2-xx15D	12V (9-18V) 24V (18-36V) 48V (36-72V)	± 5V	±500mA
CW2-xx05		5V	1000mA			± 9V	±278mA
CW2-xx09		9V	556mA			±12V	±210mA
CW2-xx12		12V	420mA			±15V	±170mA
CW2-xx15		15V	340mA				

Any other output voltages available

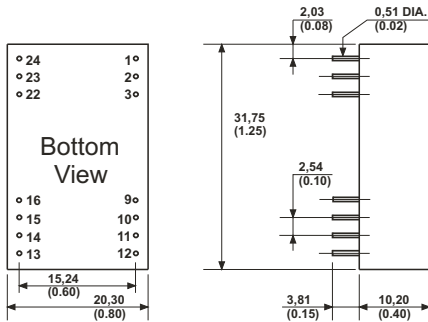

PIN CONNECTION:						
PIN	SINGLE	DUAL	SINGLE A	DUAL A	SINGLE C	DUAL C
1	+Vin	+Vin			+Vin	+Vin
2	NP	-Vout	-Vin	-Vin	+Vin	+Vin
3	NP	COM	-Vin	-Vin		
9			NC	COM		
10	-Vout	COM			NC	COM
11	+Vout	+Vout	NC	-Vout	NC	COM
12	-Vin	-Vin			-Vout	NC
13	-Vin	-Vin			+Vout	-Vout
14	+Vout	+Vout	+Vout	+Vout		
15	-Vout	COM			NC	+Vout
16			-Vout	COM		
22	NP	COM	+Vin	+Vin		
23	NP	-Vout	+Vin	+Vin	-Vin	-Vin
24	+Vin	+Vin			-Vin	-Vin

Add "A" to the end of Partnumber.
 For example CW2-2405A/H3 5Watt.

SMD-Pinning Part-No.: /SMD

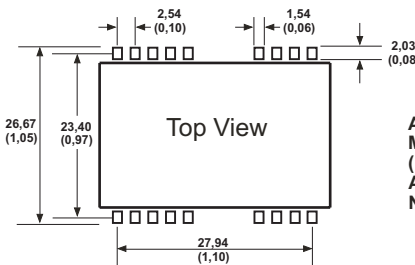
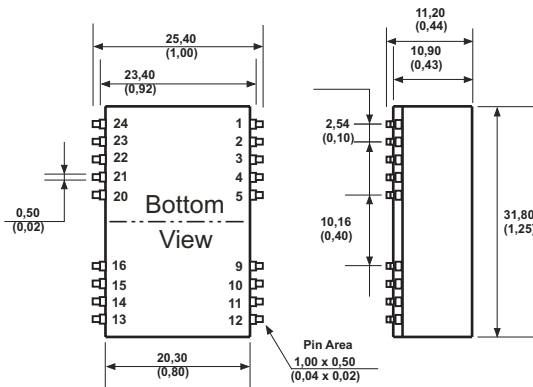

ALL DIMENSIONS IN MM (INCHES)
 MILLIMETERS +/- 0,25mm
 (INCHES +/- 0,01")
 All pins on a 2,54mm pitch
 Note: NP = No pin; NC = No connection;
 Dot denotes pin 1

Specification may be changed without notice
 please contact office for verification

We can offer EMC - Filter
 according to EN55011/22 Class B.

DC/DC Converter
 AC/DC Inverters
 Delay-Lines
 Pulsetransformers
 Burst & Surge Filters
 Harmonic Filters
 Switching Power Supplies

Am Malfinger Steig 13
 86920 Denklingen/Obb.
 Germany
 Tel.: 08243-9693-0
 Fax: 08243-9693-33
 www.floeth-electronic.com



Stand: 11/08

Wide input range 2:1
 Case style: DIP24

COMMERCIAL DC/DC Converters PWM - regulated ISOLATED OUTPUT

3 Watt / 5 Watt
 Series: CW2

Electrical specifications:

Input voltage: wide 2:1
 Output voltage accuracy: max. +/- 2%
 Line regulation: max. +/- 0,4%
 Load regulation: max. +/- 0,6% (20% to 100% Load)
 Operating temperature Uin = 5V: -40°C to +80°C
 Uin = 12V; 24V; 48V: -40°C to +85°C

Efficiency: up to 82%
 Output Ripple & Noise: typ. 50mVp-p
 Short circuit protection: continuous / Auto Restart
 Isolation voltage I/O: min. 2000V DC
 (tested for 1 second min.) O/O: min. 500V DC
 Case material: black plastic
 Part-No. /M: metal case
 Part-No. /SMD: SMD-package

CAUTION: NO INPUT POLARITY CHANGE ALLOWED!

* OUT1: (Uout = 5V) min. Load 100mA to supply OUT2 well
 (Uout = 9V; 12V; 15V) min. Load 20% to supply OUT2 well

Part - No. Dual Output	Input Voltage DC	Output 3 Watt				Output 5 Watt			
		Output 1 *		Output 2		Output 1 *		Output 2	
		Output Voltage DC	Output Current	Output Voltage DC	Output Current	Output Voltage DC	Output Current	Output Voltage DC	Output Current
CW2-xx0505A CW2-xx0509A CW2-xx0512A CW2-xx0515A	05V (4,5-9V)	5V	300mA	5V	300mA	5V	500mA	5V	500mA
CW2-xx0905A CW2-xx0909A CW2-xx0912A CW2-xx0915A		9V	167mA	9V	167mA	9V	277mA	9V	277mA
CW2-xx1205A CW2-xx1209A CW2-xx1212A CW2-xx1215A		12V	125mA	12V	125mA	12V	208mA	12V	208mA
CW2-xx1505A CW2-xx1509A CW2-xx1512A CW2-xx1515A		15V	100mA	15V	100mA	15V	167mA	15V	167mA

Input voltage range 4:1 (9-36V & 18-72V) also available

Any other output voltages available

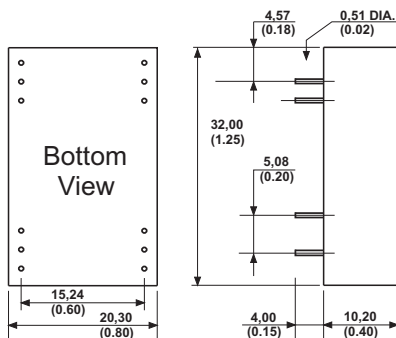

ALL DIMENSIONS IN MM
 MILLIMETERS +/- 0,25mm
 All pins on a 2,54mm pitch
 Note: NP = No pin;
 NC = No connection;
 Dot denotes pin 1

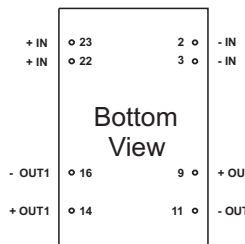
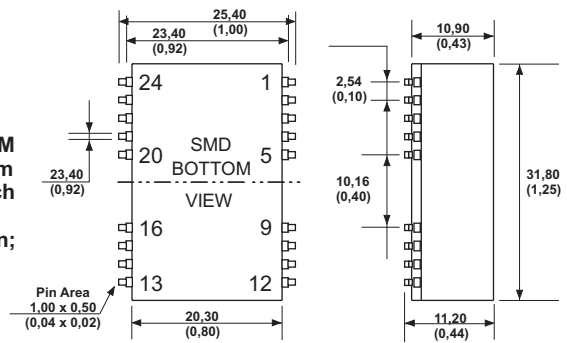

PIN CONNECTION:
 Dual Separate
 Any other Pin-Connection on request

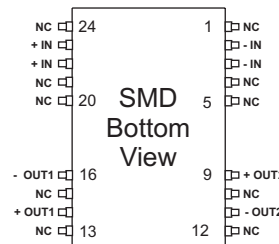

Part-No.: /SMD
 Example:
 CW2-241515A/SMD 3W

Specification may be changed without notice
 please contact office for verification

We can offer EMC - Filter
 according to EN55011/22 Class B.

DC/DC Converter
 AC/DC Inverters
 Delay-Lines
 Pulsetransformers
 Burst & Surge Filters
 Harmonic Filters
 Switching Power Supplies

Am Malfinger Steig 13
 86920 Denklingen/Obb.
 Germany
 Tel.: 08243-9693-0
 Fax: 08243-9693-33
 www.floeth-electronic.com



Stand: 12/07

COMMERCIAL DC/DC Converters PWM - regulated

**8 Watt
 Series: CW2**

Wide input range 1:2
 Case style: DIP24

Electrical specifications:

Input voltage:	wide 1:2	Output Ripple & Noise:	max.50mVp-p
Output voltage accuracy:	max. +/- 1,2%	Short circuit protection:	continuous, automatic recovery
Minimum Load:	10% of Full Load	Isolation voltage:	min. 2000V DC
Line regulation:	max. +/- 1,0%	Optional Part-No.: /H3	min. 3000V DC
Load regulation:	max. +/- 2,0% (25% to 100% Load)	Remote ON / OFF Control:	
Efficiency:	up to 87%	On - Control:	3,5V < Vr < 12V or open
Operating temperature Uin = 5V:	-40°C to +75°C	Off - Control:	0V < Vr < 1,2V or short
Uin = 12V; 24V; 48V:	-40°C to +85°C	Case material:	Nickel-coated copper
Over Load Protection		Optional Part-No.: /M	metal case
% of FL at nominal input:	150% typ	Part-No.: /SMD	SMD-package
Isolation Capacitance:	1200pF max.		

CAUTION: NO INPUT POLARITY CHANGE ALLOWED!

Part - No. Single Output	Input Voltage DC	Output Voltage DC	Output current	Part - No. Dual Output	Input Voltage DC	Output Voltage DC	Output current
CW2-xx03,3A	5V (4,5-9V)	3,3V	1600mA	CW2-xx05DA	5V (4,5-9V)	± 5V	±800mA
CW2-xx05A	12V (9-18V)	5V	1600mA	CW2-xx12DA	12V (9-18V)	±12V	±333mA
CW2-xx12A	24V (18-36V)	12V	666mA	CW2-xx15DA	24V (18-36V)	±15V	±267mA
CW2-xx15A	48V (36-72V)	15V	533mA				

Any other output voltages available

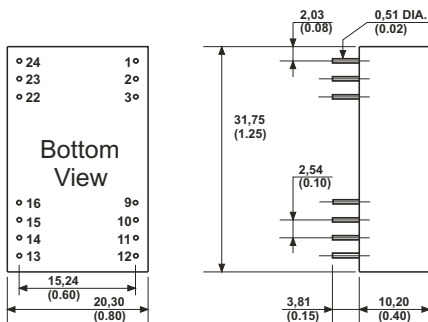

ALL DIMENSIONS IN MM (INCHES)
 MILLIMETERS +/- 0,25mm
 (INCHES +/-0,01")
 All pins on a 2,54mm pitch
 Note: NP = No pin; NC = No connection;
 Dot denotes pin 1

PIN CONNECTION:		
PIN	SINGLE A	DUAL A
1	Remote On/Off	
2	-Vin	-Vin
3	-Vin	-Vin
9	NC	COM
10		
11	NC	-Vout
12		
13		
14	+Vout	+Vout
15		
16	-Vout	COM
22	+Vin	+Vin
23	+Vin	+Vin
24		

SMD-Pinning Part-No.: /SMD

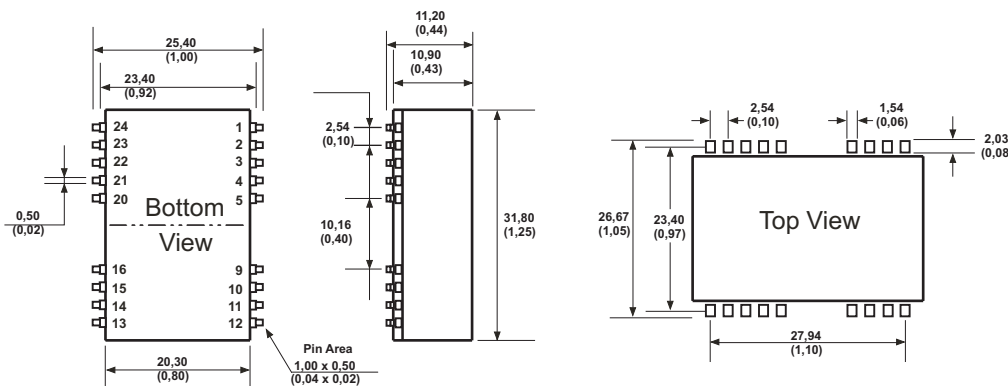

Part-No.: /H3
 Example CW2-2405A/H3 8W

Part-No.: /SMD
 Example:
 CW2-2415A/SMD 8W

Specification may be changed without notice
 please contact office for verification

We can offer EMC - Filter
 according to EN55011/22 Class B.