



#### FEATURES:

- No Minimum Load
- 24 Pin DIP Package
- Wide 2:1 Input Range
- High Efficiency up to 81%
- Over Load Protection
- Operating Temperature -40 to +85°C
- Input / Output Isolation 1500 or 3000 VDC
- Internal EMC Filter Meets EN55022 Class A
- Continuous Short Circuit Protection
- Input Under Voltage Lockout

#### Models

##### Single output



Model	Input Voltage (V)	Output Voltage (V)	Output Current Max (mA)	Isolation (VDC)	Max Capacitive Load (uF)	Input Current Full Load   No Load (mA)		Efficiency (%)
AM3TI-1203S-RZ	9-18	3.3	900	1500	470	339	7	74
AM3TI-1205S-RZ	9-18	5	600	1500	470	325	7	78
AM3TI-1212S-RZ	9-18	12	250	1500	100	313	10	81
AM3TI-1215S-RZ	9-18	15	200	1500	100	313	10	81
AM3TI-1224S-RZ	9-18	24	125	1500	47	316	20	80
AM3TI-2403S-RZ	18-36	3.3	900	1500	470	172	7	73
AM3TI-2405S-RZ	18-36	5	600	1500	470	164	7	77
AM3TI-2412S-RZ	18-36	12	250	1500	100	156	7	81
AM3TI-2415S-RZ	18-36	15	200	1500	100	156	7	81
AM3TI-2424S-RZ	18-36	24	125	1500	47	156	10	81
AM3TI-4803S-RZ	36-75	3.3	900	1500	470	84	7	75
AM3TI-4805S-RZ	36-75	5	600	1500	470	80	7	79
AM3TI-4812S-RZ	36-75	12	250	1500	100	78	7	81
AM3TI-4815S-RZ	36-75	15	200	1500	100	78	7	81
AM3TI-4824S-RZ	36-75	24	125	1500	47	78	7	81
AM3TI-1203SH30-RZ	9-18	3.3	900	3000	470	339	7	74
AM3TI-1205SH30-RZ	9-18	5	600	3000	470	325	7	78
AM3TI-1212SH30-RZ	9-18	12	250	3000	100	313	10	81
AM3TI-1215SH30-RZ	9-18	15	200	3000	100	313	10	81
AM3TI-1224SH30-RZ	9-18	24	125	3000	47	316	20	80
AM3TI-2403SH30-RZ	18-36	3.3	900	3000	470	172	7	73
AM3TI-2405SH30-RZ	18-36	5	600	3000	470	164	7	77
AM3TI-2412SH30-RZ	18-36	12	250	3000	100	156	7	81
AM3TI-2415SH30-RZ	18-36	15	200	3000	100	156	7	81
AM3TI-2424SH30-RZ	18-36	24	125	3000	47	156	10	81
AM3TI-4803SH30-RZ	36-75	3.3	900	3000	470	84	7	75
AM3TI-4805SH30-RZ	36-75	5	600	3000	470	80	7	79
AM3TI-4812SH30-RZ	36-75	12	250	3000	100	78	7	81
AM3TI-4815SH30-RZ	36-75	15	200	3000	100	78	7	81
AM3TI-4824SH30-RZ	36-75	24	125	3000	47	78	7	81

#### Models

##### Dual output

Model	Input Voltage (V)	Output Voltage (V)	Output Current Max (mA)	Isolation (VDC)	Max Capacitive Load (uF)	Input Current Full Load   No Load (mA)		Efficiency (%)
AM3TI-1203D-RZ	9-18	±3.3	±450	1500	±220	339	10	74
AM3TI-1205D-RZ	9-18	±5	±300	1500	±220	325	10	78
AM3TI-1212D-RZ	9-18	±12	±125	1500	±100	313	15	81
AM3TI-1215D-RZ	9-18	±15	±100	1500	±100	313	20	81
AM3TI-1224D-RZ	9-18	±24	±63	1500	±47	319	35	80
AM3TI-2403D-RZ	18-36	±3.3	±450	1500	±220	167	7	75
AM3TI-2405D-RZ	18-36	±5	±300	1500	±220	160	7	79
AM3TI-2412D-RZ	18-36	±12	±125	1500	±100	156	10	81
AM3TI-2415D-RZ	18-36	±15	±100	1500	±100	156	15	81
AM3TI-2424D-RZ	18-36	±24	±63	1500	±47	158	20	81

**Models**

**Dual output (continued)**

Model	Input Voltage (V)	Output Voltage (V)	Output Current Max (mA)	Isolation (VDC)	Max Capacitive Load (uF)	Input Current Full Load   No Load (mA)		Efficiency (%)
AM3TI-4803D-RZ	36-75	±3.3	±450	1500	±220	81	7	77
AM3TI-4805D-RZ	36-75	±5	±300	1500	±220	78	7	81
AM3TI-4812D-RZ	36-75	±12	±125	1500	±100	78	7	81
AM3TI-4815D-RZ	36-75	±15	±100	1500	±100	78	7	81
AM3TI-4824D-RZ	36-75	±24	±63	1500	±47	81	15	79
AM3TI-1203DH30-RZ	9-18	±3.3	±450	3000	±220	339	10	75
AM3TI-1205DH30-RZ	9-18	±5	±300	3000	±220	325	10	79
AM3TI-1212DH30-RZ	9-18	±12	±125	3000	±100	313	15	81
AM3TI-1215DH30-RZ	9-18	±15	±100	3000	±100	313	20	81
AM3TI-1224DH30-RZ	9-18	±24	±63	3000	±47	319	35	81
AM3TI-2403DH30-RZ	18-36	±3.3	±450	3000	±220	167	7	75
AM3TI-2405DH30-RZ	18-36	±5	±300	3000	±220	160	7	79
AM3TI-2412DH30-RZ	18-36	±12	±125	3000	±100	156	10	81
AM3TI-2415DH30-RZ	18-36	±15	±100	3000	±100	156	15	81
AM3TI-2424DH30-RZ	18-36	±24	±63	3000	±47	158	20	81
AM3TI-4803DH30-RZ	36-75	±3.3	±450	3000	±220	81	7	77
AM3TI-4805DH30-RZ	36-75	±5	±300	3000	±220	78	7	81
AM3TI-4812DH30-RZ	36-75	±12	±125	3000	±100	78	7	81
AM3TI-4815DH30-RZ	36-75	±15	±100	3000	±100	78	7	81
AM3TI-4824DH30-RZ	36-75	±24	±63	3000	±47	81	15	79

**Input Specifications**

Parameters	Nominal	Typical	Maximum	Units
Voltage range	12	9-18		VDC
	24	18-36		
	48	36-75		
Filter	π (Pi) Network			
Startup time		20		ms
Absolute Maximum Rating	12 Vin		25	VDC
	24 Vin		50	
	48 Vin		100	
Input Reflected Ripple Current	Refer to application test circuit	20		mA p-p
Under Voltage Lockout	12 Vin	(Model On / Off) 8.5 / 7.0		VDC
	24 Vin	(Model On / Off) 16.5 / 14.5		
	48 Vin	(Model On / Off) 34.5 / 30.0		

**Isolation Specifications**

Parameters	Conditions	Typical	Rated	Units
Tested I/O voltage	60 sec		1500 or 3000	VDC
Resistance		> 1000		MOhm
Capacitance		1000		pF

**Output Specifications**

Parameters	Conditions	Typical	Maximum	Units
Voltage Accuracy		±2		%
Voltage Balance		±2		%
Short Circuit Protection		Continuous		
Short Circuit Restart		Auto Recovery		
Over Load Protection		160% Iout		
Line Voltage Regulation		±0.5		%
Load Voltage Regulation	0 – 100% load	±1.2		%

### Output Specifications (continued)

Parameters	Conditions	Typical	Maximum	Units
Transient Recovery Time		300		µsec
Transient Deviation	(other models) (Single output 3.3V)	±3		%
Cross Regulation (Dual)	25% min load one output & 100% load on other	±5		%
Temperature Coefficient		±0.02		%/°C
Ripple & Noise *	(other models) (24V dual Models)	80 100		mV p-p

\*- 20MHz Bandwidth measured with 1µf capacitor

### General Specifications

Parameters	Conditions	Typical	Maximum	Units
Switching frequency	100% load	330		KHz
Operating temperature	Derating above 70		-40 to +85	°C
Storage temperature			-55 to +125	°C
Max Case temperature			100	°C
Cooling		Free air convection		
Humidity			95	%
Case material		Plastic (UL94V-0 rated)		
Weight		13		g
Dimensions (L x W x H)	Tolerance ±0.5 mm or ±0.02 inches	1.25 x 0.80 x 0.40 inches	31.80 x 20.30 x 10.20 mm	
MTBF		>800 000 hrs (MIL-HDBK -217F, Ground Benign, t=+25°C)		

NOTE: All specifications in this datasheet are measured at an ambient temperature of 25°C, humidity<75%, nominal input voltage and at rated output load unless otherwise specified.

### Safety Specifications

Parameters	
Agency Approval	CE, UL
Standards	IEC/EN 60950-1
	EN 55022 Class A
	EN 55024 Class A
	IEC61000-4-2, Perf. Criteria A
	IEC61000-4-3, Perf. Criteria A
	IEC61000-4-4, Perf. Criteria A
	IEC61000-4-5, Perf. Criteria A
	IEC61000-4-6, Perf. Criteria A
IEC61000-4-8, Perf. Criteria A	

### Pin Out Specifications

Pin	Single	Dual
2	-V Input	-V Input
3	-V Input	-V Input
9	Omitted	Common
11	N.C.	-V Output
14	+V Output	+V Output
16	-V Output	Common
22	+V Input	+V Input
23	+V Input	+V Input

**Dimensions**

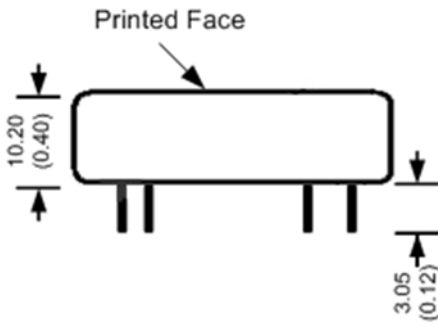
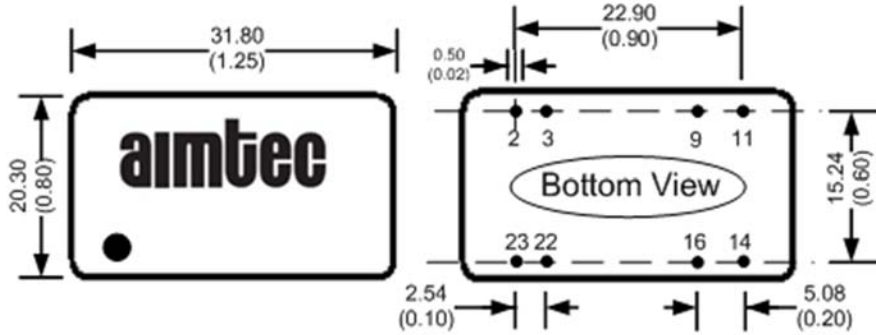

All dimensions are typical: millimeters (inches)  
 Pin Diameter:  $0.50 \pm 0.05$  ( $0.02 \pm 0.002$ )  
 Pin Pitch Tolerance:  $\pm 0.35$  ( $\pm 0.014$ )  
 Case Tolerance:  $\pm 0.5$  ( $\pm 0.02$ )

**Derating**

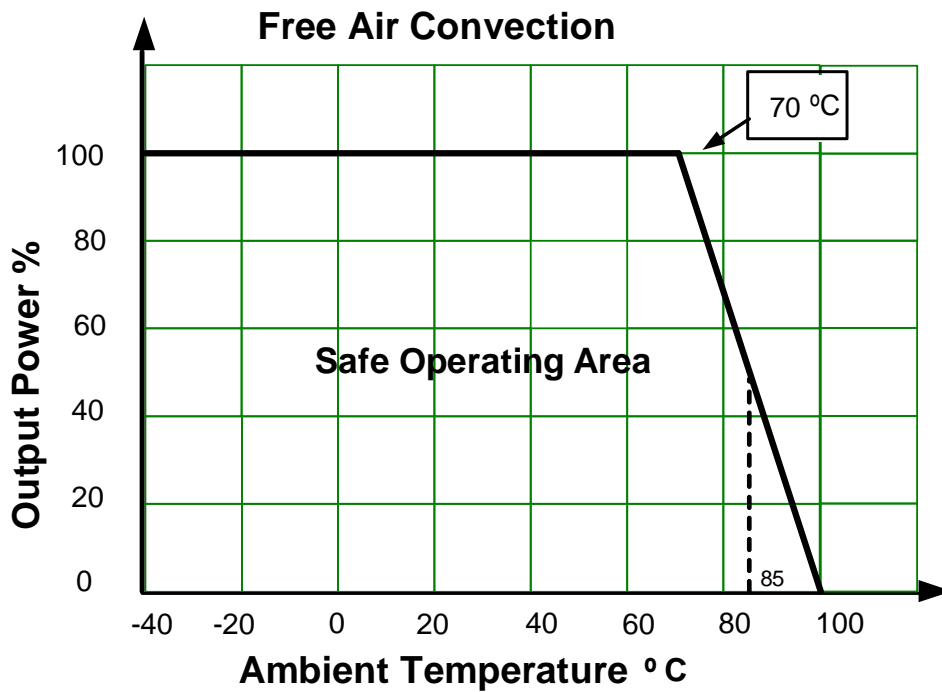

**Input Reflected Ripple Current Test Circuit**

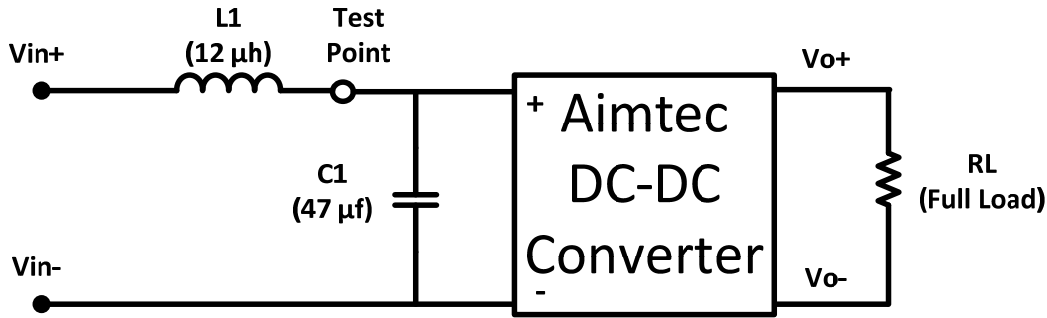

\* Tested at full load, and nominal input

**Typical Efficiency Example Charts**

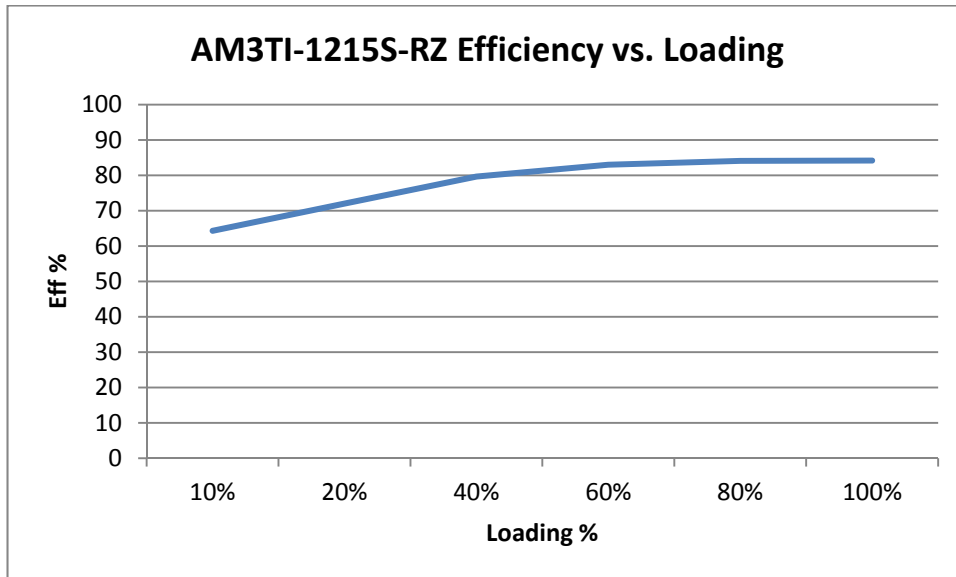

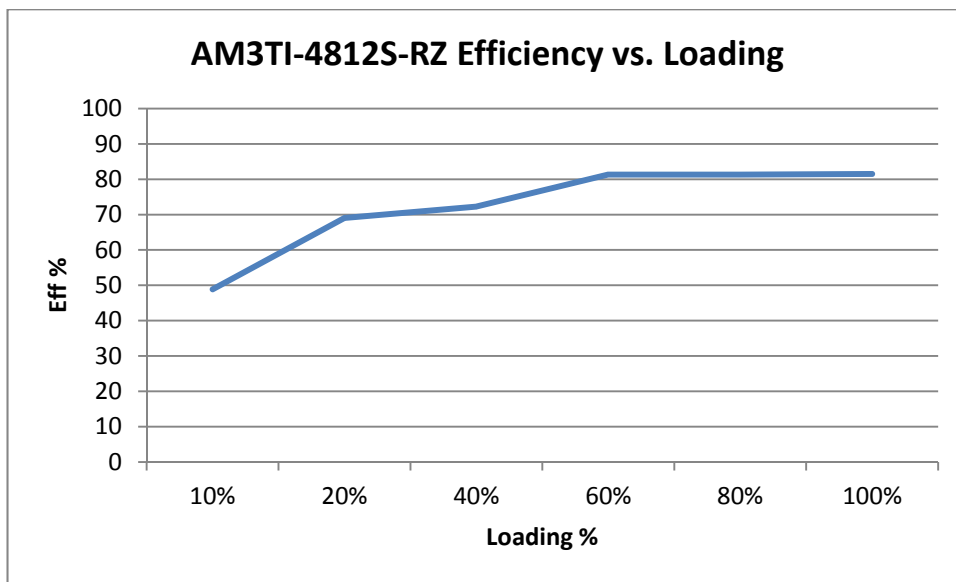
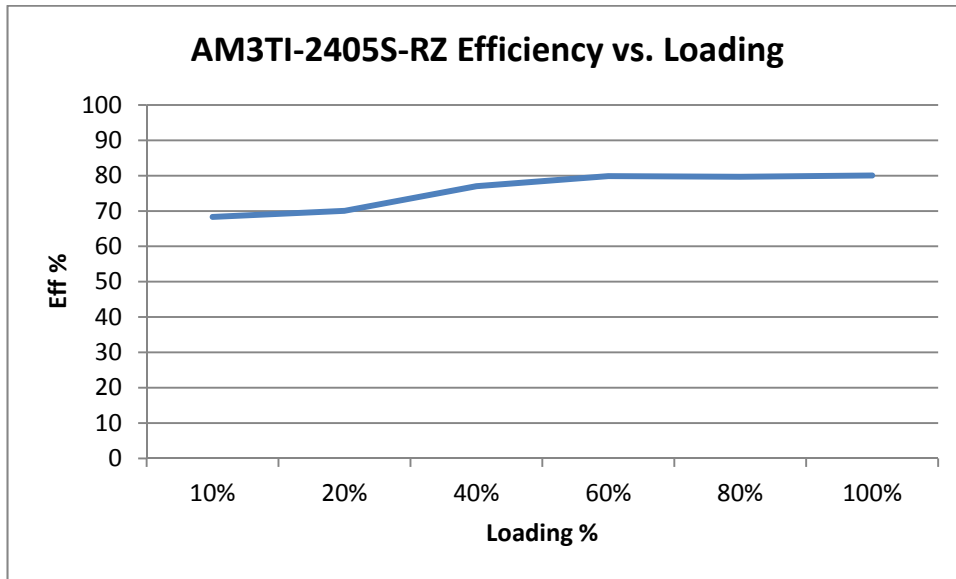

**NOTE:** **1.** Datasheets are updated as needed and as such, specifications are subject to change without notice. Once printed or downloaded, datasheets are no longer controlled by Aimtec; refer to [www.aimtec.com](http://www.aimtec.com) for the most current product specifications. **2.** Product labels shown, including safety agency certifications on labels, may vary based on the date manufactured. **3.** Mechanical drawings and specifications are for reference only. **4.** All specifications are measured at an ambient temperature of 25°C, humidity<75%, nominal input voltage and at rated output load unless otherwise specified. **5.** Aimtec may not have conducted destructive testing or chemical analysis on all internal components and chemicals at the time of publishing this document. CAS numbers and other limited information are considered proprietary and may not be available for release. **6.** This product is not designed for use in critical life support systems, equipment used in hazardous environments, nuclear control systems or other such applications which necessitate specific safety and regulatory standards other the ones listed in this datasheet. **7.** Warranty is in accordance with Aimtec's standard Terms of Sale available at [www.aimtec.com](http://www.aimtec.com).