

# Features

- Efficiency up to 95%, Non isolated, no need for heatsinks
- Pin-out compatible with LM78XX Linear
- Low profile (L\*W\*H=11.5\*8.5\*17.5mm)
- Wide input range. (4.75V ~ 18V)
- Short circuit protection, Thermal shutdown
- Non-standard outputs available as specials between 1.5V ~ 6.5V
- Low ripple and noise
- "L" Version with 90° pins

## Description

The R-78Bxx-1.5 Series high efficiency switching regulators are ideally suited to replace 78xx linear regulators and are pin compatible. The efficiency of up to 95% means that very little energy is wasted as heat so there is no need for any heat sinks with their additional space and mounting costs. The L-Version with 90° pins allows direct replacement for laid-flat regulators where component height is at a premium. Low ripple and noise figures and a short circuit input current of typically only 10mA round off the specifications of this versatile converter series.

## Selection Guide

| Part Number*<br>SIP3 | Input Range (V) | Output Voltage (V) | Output Current (A) | Efficiency   |              |
|----------------------|-----------------|--------------------|--------------------|--------------|--------------|
|                      |                 |                    |                    | Min. Vin (%) | Max. Vin (%) |
| R-78B1.5-1.5         | 4.75 – 18       | 1.5                | 1.5                | 83           | 78           |
| R-78B1.8-1.5         | 4.75 – 18       | 1.8                | 1.5                | 85           | 81           |
| R-78B2.5-1.5         | 4.75 – 18       | 2.5                | 1.5                | 88           | 84           |
| R-78B3.3-1.5         | 4.75 – 18       | 3.3                | 1.5                | 91           | 88           |
| R-78B5.0-1.5         | 6.5 – 18        | 5.0                | 1.5                | 94           | 92           |
| R-78B6.5-1.5         | 8.0 – 18        | 6.5                | 1.5                | 95           | 93           |

\* add Suffix "L" for 90° bent pins, e.g. R-78B5.0-1.5L

## Specifications (refer to the standard application circuit, Ta: 25°C, minimum load = 10%)

| Characteristics   | Conditions  | Min.                           | Typ.   | Max.      |
|---|---|--------------------------------|--------|-----------|
| Input Voltage Range                                       | All Series, see Selection Guide                         | 4.75V                          |        | 18.0V     |
| Output Voltage Range (for customized parts)               | All Series  | 1.5V                           |        | 6.5V      |
| Output Current  | All Series  | 0mA*                           |        | 1500mA    |
| Short Circuit Input Current (Vin = 12V)                   | All Series  |                                |        | 100mA     |
| Internal Power Dissipation                                |   |                                |        | 0.65W     |
| Short Circuit Protection                                  |   | Continuous, automatic recovery |        |           |
| Output Voltage Accuracy (At 100% Load)                    | All Series  |                                | ±2%    | ±3%       |
| Line Voltage Regulation (Vin = min. to max. at full load) | All Series  |                                | 0.3%   | 0.5%      |
| Load Regulation (10% to 100% full load)                   | All Series  |                                | 0.6%   | 0.8%      |
| Dynamic Load Stability (with Output Capacitor=100µF)      | 100% <-> 50% load                                       |                                | ±80mV  | ±120mV    |
| Transient Recovery Time                                   |   | 1.0ms                          | 1.5ms  |           |
| Ripple & Noise (10% to 100% full load)                    | All Series  |                                | 15mV   | 30mVp-p   |
| Temperature Coefficient                                   | -40°C ~ +85°C ambient                                   |                                |        | 0.015%/°C |
| Max capacitance Load                                      | with normal start-up time, no external components       |                                |        | 1000µF    |
|   | with <1 second start up time + diode protection circuit |                                |        | 6800µF    |
| Switching Frequency                                       |   | 300kHz                         | 340kHz | 380kHz    |

continued on next page

# INNOLINE DC/DC-Converter

with year Warranty

## RECOM

# 1.5 AMP SIP3 Single Output



**EN-55022 Certified**  
**EN-55024 Certified**  
**IEC/EN-60950-1 Certified**

# R-78B-1.5

## Derating-Graph (Ambient Temperature)

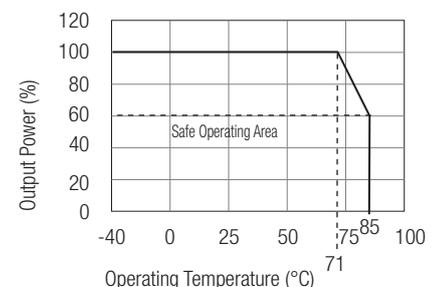

Refer to Application Notes

**Specifications** (refer to the standard application circuit, Ta: 25°C, minimum load = 10%)

| Characteristics                | Conditions   | Min.   | Typ.                        | Max.                         |
|--------------------------------|--|--|-----------------------------|------------------------------|
| Quiescent Current              | Vin = min. to max. at 0% load                                  |  | 7mA                         | 9mA                          |
| Input Reflected Ripple Current | All Series   |  | 150mA                       | 200mA p-p                    |
| Operating Temperature Range    |  | -40°C  |                             | +85°C                        |
| Operating Case Temperature     |  |  |                             | +100°C                       |
| Storage Temperature Range      |  | -55°C  |                             | +125°C                       |
| Case Thermal Impedance         |  |  |                             | 60°C / W                     |
| Relative Humidity              |  |  |                             | 95% RH                       |
| Case Material                  |  | Epoxy with Non-Conductive Plastic Case (UL94V-0) |                             |                              |
| Package Weight                 |  |  | 4g                          |                              |
| Packing Quantity               |  |  |                             | 42 pcs per Tube              |
| Conducted Emissions            | EN55022  |  |                             | Class B                      |
| Radiated Emissions             | EN55022  |  |                             | Class B                      |
| ESD                            | EN61000-4-2  |  |                             | Class A                      |
| IEC/EN General Safety          | Report: SPCLVD 1407030-1                                       |  | IEC/EN-60950-1, 2nd Edition |                              |
| MTBF (+25°C)                   | } Detailed Information see<br>Application Notes chapter "MTBF" | using MIL-HDBK 217F                              |                             | 3250 x 10 <sup>3</sup> hours |
| (+71°C)                        |  | using MIL-HDBK 217F                              |                             | 1059 x 10 <sup>3</sup> hours |

**\*Note:** Operation under no load will not damage these devices, however they may not meet all specifications. A minimum load of 10mA is recommended

**Typical Application Circuit**

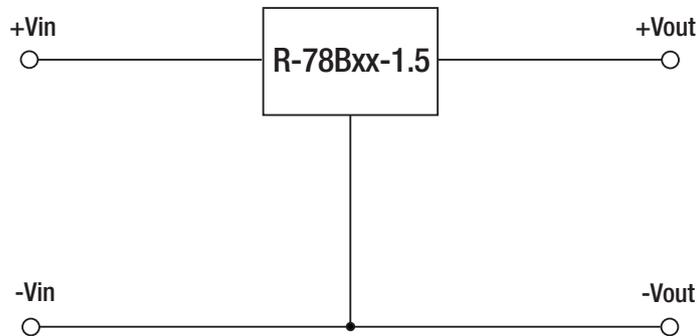

R-78B-1.5

**Characteristics**

## Efficiency

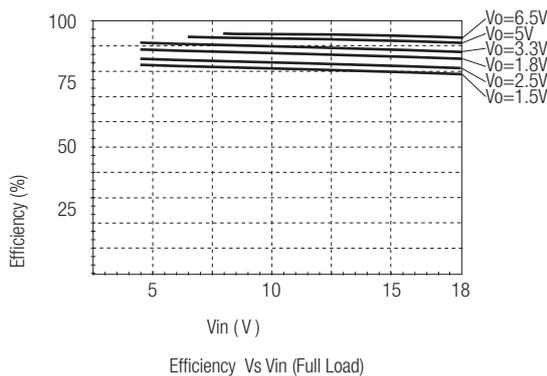

## Ripple

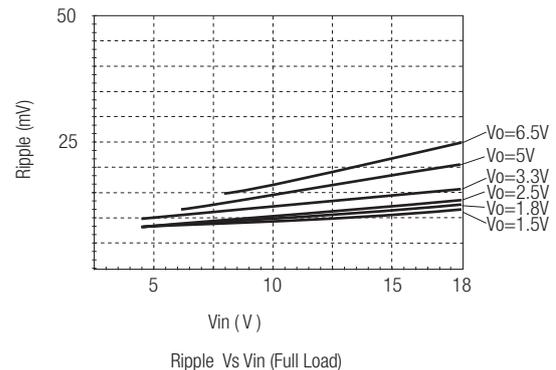

**Characteristics**

## Efficiency

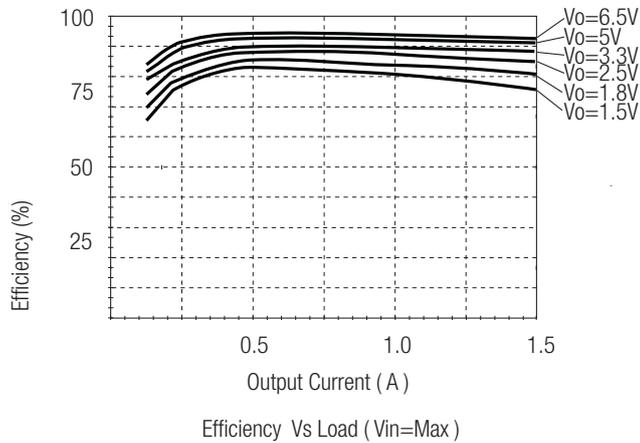

Efficiency Vs Load (Vin=Max)

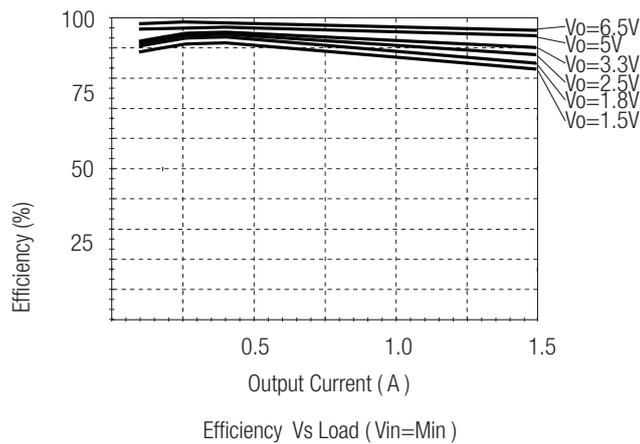

Efficiency Vs Load (Vin=Min)

## Ripple

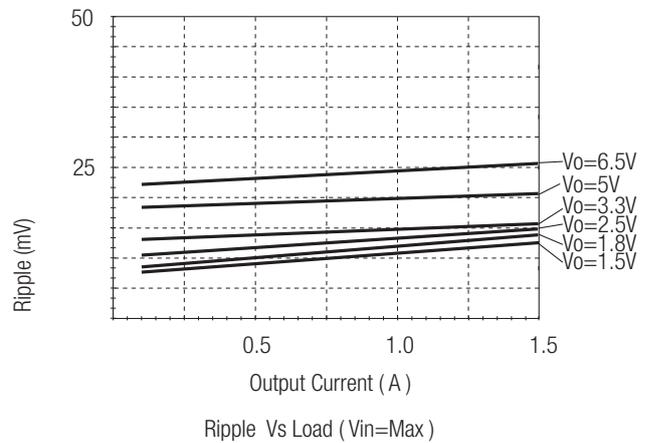

Ripple Vs Load (Vin=Max)

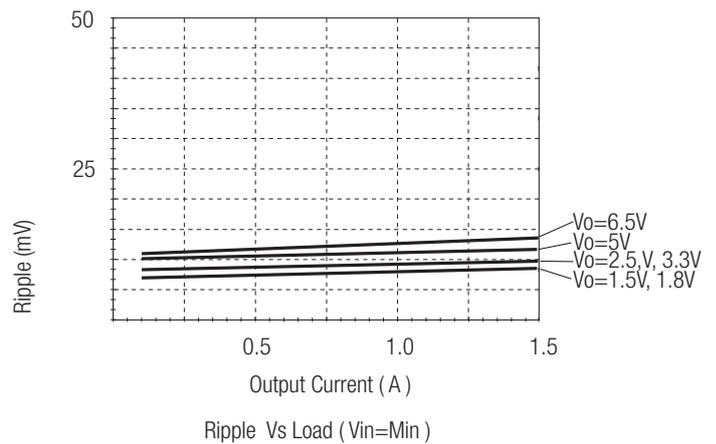

Ripple Vs Load (Vin=Min)

R-78B-1.5

## Optional Protection Circuit

### Optional Protection 1:

Add a blocking diode to Vout if current can flow backwards into the output, as this can damage the converter when it is powered down.

The diode can either be fitted across the device if the source is low impedance or fitted in series with the output (recommended).

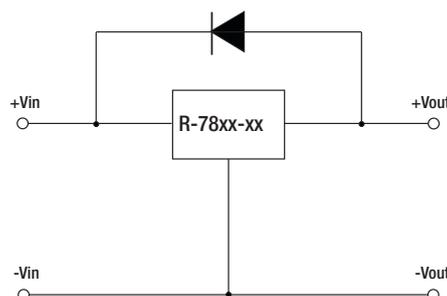

### Optional Protection 2:

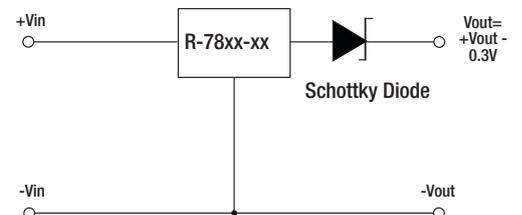

## Application Examples

### High efficiency multiple output

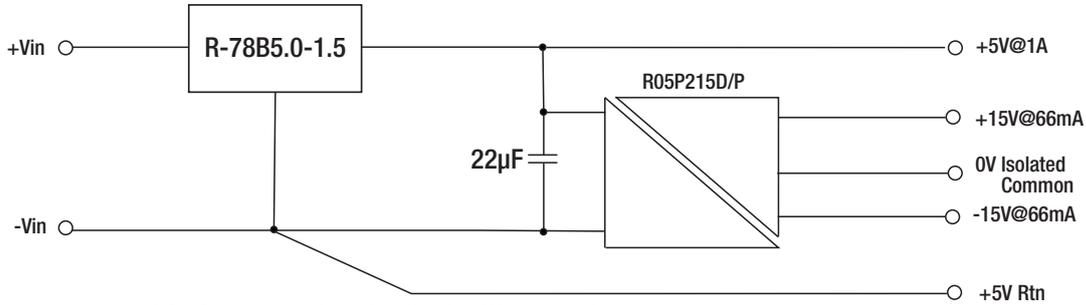

- Wide input range suits both 12V and 7.2V battery packs
- 5.2kV isolated short circuit protected outputs for analogue circuits, e.g. medical grade interface
- High efficiency +5V/1A protected output for digital circuits
- Further decoupling filtering may be necessary between the converters

### Isolated, wide Input range, Distributed Power Architecture (Point of Load)

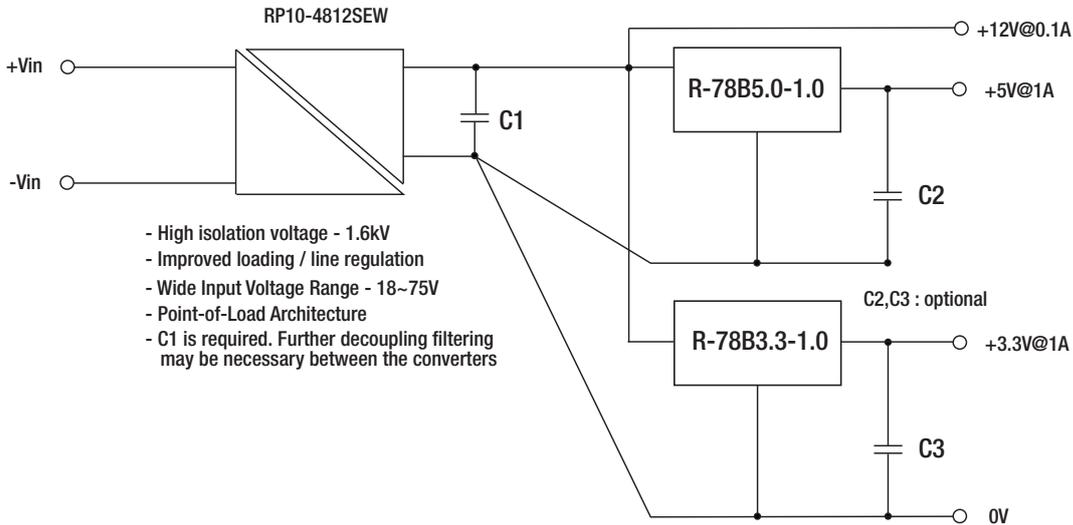

- High isolation voltage - 1.6kV
- Improved loading / line regulation
- Wide Input Voltage Range - 18~75V
- Point-of-Load Architecture
- C1 is required. Further decoupling filtering may be necessary between the converters

R-78B-1.5

## Package Style and Pinning (mm)

### SIP3 PIN Package

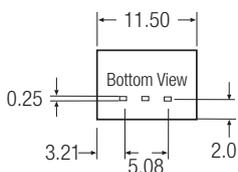
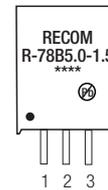
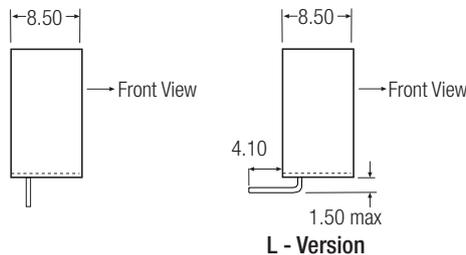
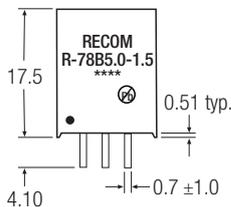

### Recommended Footprint Details

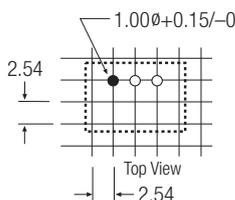

### Pin Connections

| Pin # | Connection |
|-------|------------|
| 1     | +Vin       |
| 2     | GND        |
| 3     | +Vout      |

xx.x ±0.5mm  
xx.xx ±0.25mm