

## FEATURES

- ◆ Footprint from 1.17cm<sup>2</sup>
- ◆ I/O isolation voltage 1000VDC
- ◆ Operating Temperature: -40°C ~ + 85°C
- ◆ High efficiency up to 80%
- ◆ Fully encapsulated toroidal magnetics
- ◆ Internal SMD construction
- ◆ Power density up to 0.85W/cm<sup>3</sup>
- ◆ No electrolytic or tantalum capacitors
- ◆ 5V, 9V, 12V and 15V output
- ◆ No heatsink required
- ◆ Dual output from a single input rail
- ◆ UL 94V-0 package material
- ◆ No external components required
- ◆ Industry standard pinout
- ◆ Power sharing on output
- ◆ MTTF up to 3.1 million hours

## MODEL SELECTION

**A<sup>①</sup>05<sup>②</sup>05<sup>③</sup>X<sup>④</sup>S<sup>⑤</sup>-1W<sup>⑥</sup>**

- ① Product Series
- ② Input Voltage
- ③ Output Voltage
- ④ Fixed Input
- ⑤ SIP Package
- ⑥ Rated Power

## APPLICATIONS

The A\_X(S)D series of industrial temperature range DC/DC converters are the standard building blocks for on-board distributed power systems. They are ideally suited for providing dual rail supplies on primarily digital boards with the added benefit of galvanic isolation to reduce switching noise. All of the rated power may be drawn from a single pin provided the total load does not exceed 1 Watt.



## SELECTION GUIDE

Order code	Input		Output		Efficiency (% Typ.)	Isolation Capacitance pF	MTTF <sup>1</sup> KHrs
	Voltage(VDC)	Current (mA)	Voltage (VDC)	Current (mA)			
	Nominal	MAX					
A0505XS-1W	5	289	±5	±100	69	28	3103
A0509XS-1W	5	267	±9	±55	75	32	2257
A0512XS-1W	5	260	±12	±42	77	34	1579
A0515XS-1W	5	256	±15	±33	78	36	1065
A1205XS-1W	12	120	±5	±100	69	33	2193
A1209XS-1W	12	113	±9	±55	74	46	1734
A1212XS-1W	12	111	±12	±42	75	55	1303
A1215XS-1W	12	110	±15	±33	76	54	932
A1505XS-1W	15	91	±5	±100	71	39	1941
A1512XS-1W	15	87	±12	±42	78	68	790
A2412XS-1W	24	52	±12	±42	80	65	134
A2415XS-1W	24	52	±15	±33	80	95	101
A4805XS-1W	48	30	±5	±100	70	26	206
A4809XS-1W	48	26	±9	±55	80	38	174
A4812XS-1W	48	26	±12	±42	80	52	139
A4815XS-1W	48	26	±15	±33	80	56	104
A0505XD-1W	5	289	±5	±100	69	28	3103
A0509XD-1W	5	267	±9	±55	75	32	2257
A0512XD-1W	5	260	±12	±42	77	34	1579
A0515XD-1W	5	256	±15	±33	78	36	1065
A1205XD-1W	12	120	±5	±100	69	33	2193
A1209XD-1W	12	113	±9	±55	74	46	1734
A1212XD-1W	12	111	±12	±42	75	55	1303
A1215XD-1W	12	110	±15	±33	76	54	932
A1505XD-1W	15	91	±5	±100	71	39	1941
A1512XD-1W	15	87	±12	±42	78	68	790
A2412XD-1W	24	52	±12	±42	80	65	134
A2415XD-1W	24	52	±15	±33	80	95	101
A4805XD-1W	48	30	±5	±100	70	26	206
A4809XD-1W	48	26	±9	±55	80	38	174
A4812XD-1W	48	26	±12	±42	80	52	139
A4815XD-1W	48	26	±15	±33	80	56	104

1. Calculated using MIL-HDBK-217F with nominal input voltage at full load.

All specifications typical at TA=25°C, nominal input voltage and rated output current unless otherwise specified.

## Input Characteristics

Parameter	Conditions	Min.	Typ.	Max.	Units
Voltage range	Continuous operation, 5V input	4.5	5	5.5	VDC
	Continuous operation, 12V input	10.8	12	13.2	VDC
	Continuous operation, 15V input	13.5	15	16.5	VDC
	Continuous operation, 24V input	21.6	24	26.4	VDC
	Continuous operation, 48V input	43.2	48	52.8	VDC
Reflected ripple current			20	40	mA p-p

## Absolute Maximum Ratings

Parameter	Conditions
Lead temperature 1.5mm from case for 10 seconds	300°C
Internal power dissipation	450mW
Input voltage V <sub>i</sub> , A05 types	7V
Input voltage V <sub>i</sub> , A12 types	15V
Input voltage V <sub>i</sub> , A15 types	18V
Input voltage V <sub>i</sub> , A24 types	28V
Input voltage V <sub>i</sub> , A48 types	54V

### Output Specifications

Parameter	Conditions	Min.	Typ.	Max.	Units
Rated Power	TA= -40°C to 120°C			1.0	W
Rated Power(A24、A48)	TA=0°C to 70°C			1.0	W
Voltage Set Point Accuracy	See tolerance envelope				
Line regulation	High VIN to low VIN		1.0	1.2	%%
Line regulation(A24、A48)	High VIN to low VIN			1.2	%%
Load regulation(A24、A48)	10% load to rated load, 5V output types			15	%
	10% load to rated load, all other output types			10	%
Load regulation(5V input, 12V input)	10% load to rated load, 5V output types		10	12.5	%
	10% load to rated load, 9V output types		9	10	%
	10% load to rated load, 12V output types		6.5	7.5	%
	10% load to rated load, 15V output types		6	7.0	%
Load regulation(15V input)	10% load to rated load, 5V output types		5.5	10	%
	10% load to rated load, 12V output types		2.6	3.0	%
	10% load to rated load, 15V output types		2.3	3.0	%
Ripple & Noise(A24、A48)	BW=DC to 20MHz, all input types			150	mV p-p
Ripple & Noise	BW=DC to 20MHz, 5V output types		10	20	mV p-p
	BW=DC to 20MHz, 9V output types		7	15	mV p-p
	BW=DC to 20MHz, 12V output types		7.5	15	mV p-p
	BW=DC to 20MHz, 15V output types		8	15	mV p-p

### Isolation Characteristics

Parameter	Conditions	Min.	Typ.	Max.	Units
Isolation voltage	Flash tested for 1 second	1000			VDC
Resistance	Viso= 1000VDC		10		GΩ
Resistance(A24、A48)	Viso= 500VDC	10			GΩ

### General Characteristics

Parameter	Conditions	Min.	Typ.	Max.	Units
Switching frequency	5V input types		110		kHz
	12V input types		140		kHz
	15V input types		90		kHz
Switching frequency(A24、A48)	All input types		100		kHz

### Temperature Characteristics

Parameter	Conditions	Min.	Typ.	Max.	Units
Specification	A05、A12、A15	-40		85	°C
Specification	A24、A48	0		70	°C
Storage	A05、A12、A15	-50		130	°C
Storage	A24、A48	-55		150	°C
Case temperature rise	0505,1205		33		°C
	0509,0512,0515,1209,1212,1215		28		°C
	1505		26		°C
ambient	1512,1515		17		°C
Cooling	Free air convection				

### Temperature derating graph

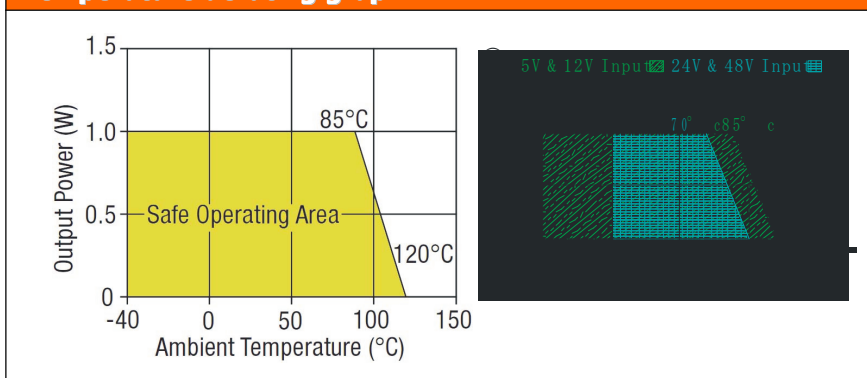

### Tolerance envelope

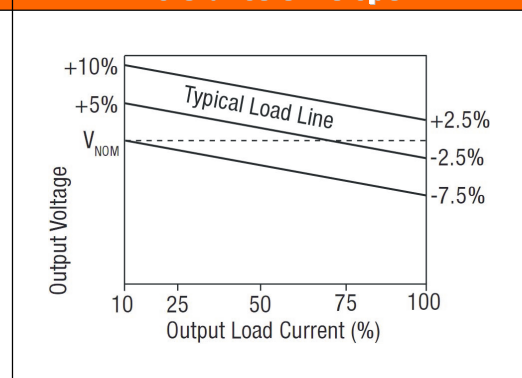

### Technical notes

#### ISOLATION VOLTAGE

"Hi Pot Test", "Flash Tested", "Withstand Voltage", "Dielectric Withstand Voltage" & " Isolation Test Voltage" are all terms that relate to the same thing, a test voltage.

Applied for a specified time, across a component designed to provide electrical isolation, to verify the integrity of that isolation.

Professional Power Module A series of DC/DC converters are all 100% production tested at their stated isolation voltage. This is 1KVDC for 1 second.

A question commonly asked is, "What is the continuous voltage that can be applied across the part in normal operation?"

For a part holding no specific agency approvals, such as the A series, both input and output should normally be maintained within SELV limits i.e. less than 42.4V peak, or 60VDC. The isolation test voltage represents a measure of immunity to transient voltages and the part should never be used as an element of a safety isolation system. The part could be expected to function correctly with several hundred volts offset applied continuously across the isolation barrier, but then the circuitry on both sides of the barrier must be regarded as operating at an unsafe voltage and further isolation/insulation systems must form a barrier between these circuits and any user-accessible circuitry according to safety standard requirements.

#### REPEATED HIGH-VOLTAGE ISOLATION TESTING

It is well known that repeated high-voltage isolation testing of a barrier component can actually degrade isolation capability, to a lesser or greater degree depending on materials. Construction and environment. The A series has toroidal isolation transformers, with no additional insulation between primary and secondary windings of enameled wire. While parts can be expected to withstand several times the stated test voltage, the isolation capability does depend on the wire insulation. Any material, including this enamel (typically polyurethane) is susceptible to eventual chemical degradation when subject to very high applied voltages thus implying that the number of tests should be strictly limited. We therefore strongly advise against repeated high voltage isolation testing, but if it is absolutely required, that the voltage be reduced by 20% from specified test voltage.

This consideration equally applies to agency recognized parts for better than functional isolation where the wire enamel insulation is always supplemented by a further insulation system of physical spacing or barriers.

### Technical notes

#### Output ripple reduction

By using the values of inductance and capacitance stated, the output ripple at the rated load is lowered to 5mV p-p max.

##### Component selection

Capacitor: Ceramic chip capacitors are recommended. It is required that the ESR(Equivalent Series Resistance) should be as low as possible. X7R types are recommended.

The voltage rating should be at least twice(except for 15V output), the rated output voltage of the DC/DC converter.

Inductor: The rated current of the inductor should not be less than of the output of the DC/DC converter. At the rated current, the DC resistance of the inductor should be such that the voltage drop across the inductor is <2% of the rated voltage of the DC/DC converter. The SRF(Self Resonant Frequency) should be >20MHz.

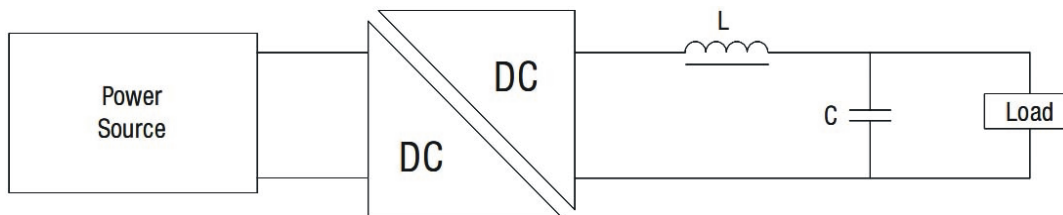

#### Ripple & Noise Characterisation Method

Ripple and noise measurements are performed with the following test configuration.

C1	1 $\mu$ F X7R multilayer ceramic capacitor, voltage rating to be a minimum of 3 times the output voltage of the DC/DC converter
C2	10 $\mu$ F tantalum capacitor, voltage rating to be a minimum of 1.5 times the output voltage of the DC/DC converter with an ESR of less than 100m $\Omega$ at 100 KHz
C3	100nF multilayer ceramic capacitor, general purpose
R1	450 $\Omega$ resistor, carbon film, $\pm$ 1% tolerance
R2	50 $\Omega$ BNC termination
T1	3T of the coax cable through a ferrite toroid
RLOAD	Resistive load to the maximum power rating of the DC/DC converter. Connections should be made via twisted wires
R3	50 $\Omega$ resistor, carbon film, $\pm$ 1%

Measured values are multiplied by 10 to obtain the specified values.

#### Differential Mode Noise Test Schematic

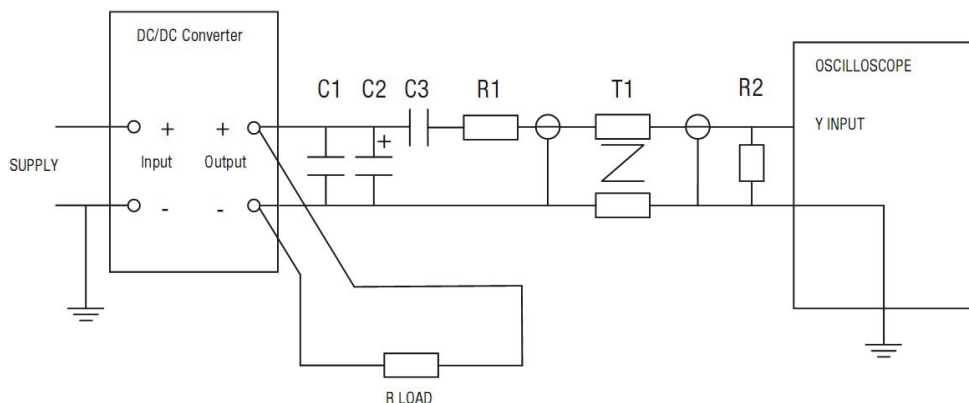

### OUTLINE DIMENSIONS & FOOTPRINT DETAILS

#### MECHANICAL DIMENSIONS

##### DIP Package

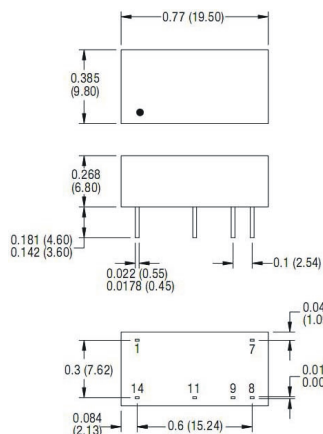

##### SIP Package

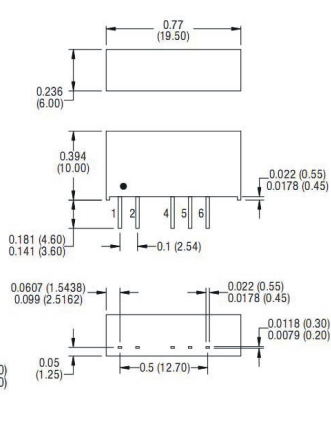

All dimensions in inches  $\pm 0.01$  (mm  $\pm 0.25$ mm). All pins on a 0.1 (2.54) pitch and within  $\pm 0.01$  (0.25) of true position.  
Weight: 2.4g (DIP) 2.1g (SIP)

#### FOOTPRINT DETAILS

##### -14 PIN DIP

Pin	Function
1	-Vin
7	NC
8	0V
9	+Vout
11	-Vout
14	+Vin

##### -7 PIN SIP

Pin	Function
1	+Vin
2	-Vin
4	-Vout
5	0V
6	+Vout

NC - Not available for electrical connection.

Specifications can be changed any time without notice.

No parallel connection or plug and play.

Note:

- The load shouldn't be less than 10%, otherwise ripple will increase dramatically.
- Operation under 10% load will not damage the converter; However, they may not meet all specification listed.
- All specifications measured at Ta=25°C, humidity<75%, nominal input voltage and rated output load unless otherwise specified.
- In this datasheet, all the test methods of indications are based on corporate standards.

#### Recommended footprint details

##### 14 PIN DIP Package

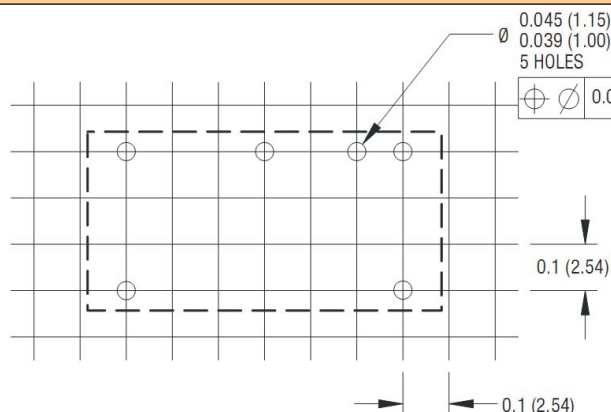

##### 7 PIN SIP Package

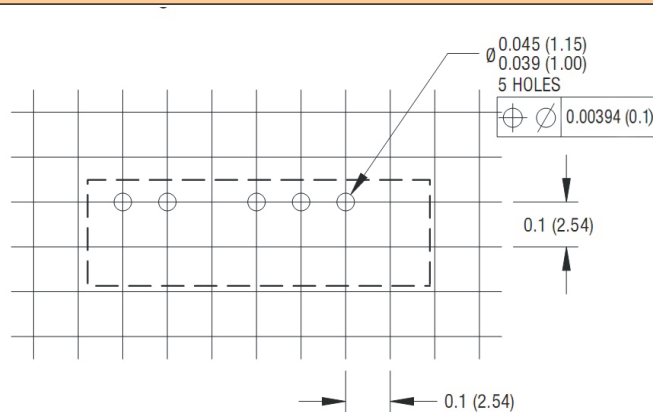

#### TUBE OUTLINE DIMENSIONS

##### 14 PIN DIP Tube

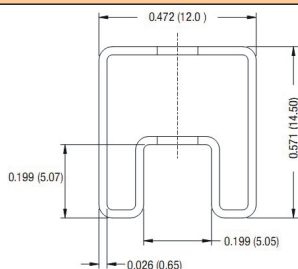

##### 7 PIN SIP Tube

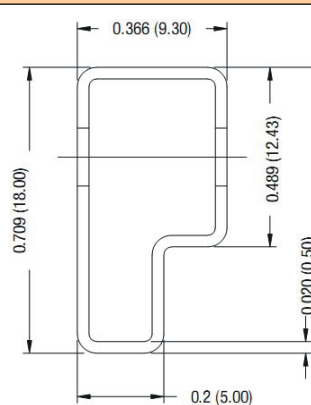

Unless otherwise stated all dimensions in inches (mm)  $\pm 0.5$ mm.

Tube length (14 Pin DIP) : 20.47 (520mm  $\pm 2$ mm).

Tube length (7 Pin SIP) : 20.47 (520mm  $\pm 2$ mm).

Tube Quantity :25