



FEATURES

- ◆ Efficiency up to 92%
- ◆ No heatsink required
- ◆ 1.0AMP SMD package
- ◆ Super low ripple and noise
- ◆ Adjustable output voltage
- ◆ Remote ON/OFF control
- ◆ Short circuit protection
- ◆ Low control current
- ◆ Operating temperature: -40°C ~ +85°C

MODEL SELECTION

WRN78^①05^②T^③-1000^④

- ① Product Series ② Output Voltage
③ SMD Package Style ④ Output Current

APPLICATIONS

The WRN78xT-1000 series with high efficiency switching regulators are ideally supply for space constrained mobile applications. There is no need for any heatsinks. The additional features include remote ON/OFF control and adjustable output voltage. Super low ripple and noise of typically only 20mV and Low control current.

PRODUCT PROGRAM

Part Number	Input Voltage(VDC)		Input Current (mA)	Output Voltage (VDC)		Current (mA)	Efficiency(% Typ)	
	Nominal	Range		Normal	Adjust Range		Vin (min.)	Vin (max.)
WRN781.5T-1000	12	5.0-18	165	1.5	fixed	1000	76	73
WRN781.8T-1000	12	5.0-18	190	1.8	1.5-3.6	1000	78	75
WRN782.5T-1000	12	5.0-18	245	2.5	1.5-3.9	1000	82	82
WRN7803T-1000	12	5.0-18	320	3.3	1.8-5.5	1000	84	84
WRN7805T-1000	12	7.0-18	460	5.0	2.5-6.5	1000	90	88
WRN786.5T-1000	12	8.5-18	580	6.5	fixed	1000	92	91

Note: To adjust the output voltage must be met $V_{in}-V_o > 2V$.
Input Current measured at nominal input voltage and rated output load.

INPUT SPECIFICATIONS

Item	Test Conditions	Min.	Typ.	Max.	Units
Input Filter		Capacitor (10μF)			
Start Current(RMS)			0.95	1.1	A

OUTPUT SPECIFICATIONS

Item	Test Conditions	Min.	Typ.	Max.	Units
Output Voltage Accuracy	Input voltage range at full load		±2	±3	%
Line Regulation			±0.2	±0.5	
Load Regulation	Nominal input, 10% to 100% load		±0.4	±1.0	
Ripple and Noise*	20MHz bandwidth		20	35	mVp-p
	20MHz bandwidth(refer to Figure 6)		10	15	
Short Circuit Protection Mode	Hiccup Mode				
Short Circuit Protection	Continuous, automatic recovery				
Inside Wasted				0.5	W
Thermal Shutdown	Internal IC junction		150		°C
Output current limit			1.8		A
Switching Frequency	PWM type		1.4		MHz
Transient peak deviation	Input voltage range, 10% to 100% load		±75	±100	mV
Transient recovery time				100	
Quiescent current			1	3	mA
Temperature Coefficient	-40°C ~ +85°C ambient			±0.02	%/°C
Max Capacitance Load				1000	μF
Remote ON/OFF	ON	Open or $1.2 < V_c < 6V$			
	OFF	$V_c < 0.6V$			
ON/OFF Control Current	ON: Open or $1.2 < V_c \leq 6V$ OFF: GND or $V_c < 0.4V$		100	200	μA
Shutdown Input Current			120	200	

*Test ripple and noise by "parallel cable" method.

COMMON SPECIFICATIONS

Item	Test Conditions	Min.	Typ.	Max.	Units
Storage humidity Range				95	%
Operating Temperature Range	Power derating(above 71°C)	-40		+85	°C
Storage Temperature Range		-55		+125	
Operating Case Temperature				+100	
Lead Temperature	1.5mm from case for 10 seconds			260	
Cooling		Free Air Convection			



CE REACH

MICRODC reserves the copyright

COMMON SPECIFICATIONS

Item	Test Conditions	Min.	Typ.	Max.	Units
Case Material		Plastic (UL94-V0)			
MTBF	(MIL-HDBK-217F,+25°C)	1000			k hours
Hop swap		Not supported			
Thermal resistance				90	°C/ W
Weight			2.3		g

EMC SPECIFICATIONS

CE	EN55022, CLASS A(without external circuit)	
	EN55022, CLASS B(refer to Figure 4)	
RE	EN55022, CLASS A(refer to Figure 5)	
ESD	IEC/EN61000-4-2 Air ±8KV / Contact ±6KV perf. Criteria B	
EFT	IEC/EN61000-4-4 ±2KV perf. Criteria B	
Surge	IEC/EN61000-4-5 ±2KV perf. Criteria B(refer to Figure 4)	

TYPICAL APPLICATION CIRCUIT

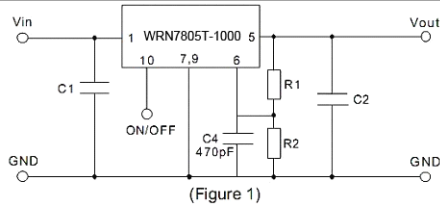

- C1, C2 is required for best performance and should be fitted close to the converter pins.
- The capacitance of C1, C2 sees external capacitor table, it can be increased properly if required, and tantalum or low ESR electrolytic capacitors may also suffice.
- No parallel connection or plug and play.

EXTERNAL CAPACITOR TABLE

Part Number	C1 (Ceramic Capacitor)	C2 (Ceramic Capacitor)
WRN7803T-1000	10μF/25V	22μF/16V
WRN7805T-1000	10μF/25V	22μF/16V

TYPICAL TEMPERATURE CURVE

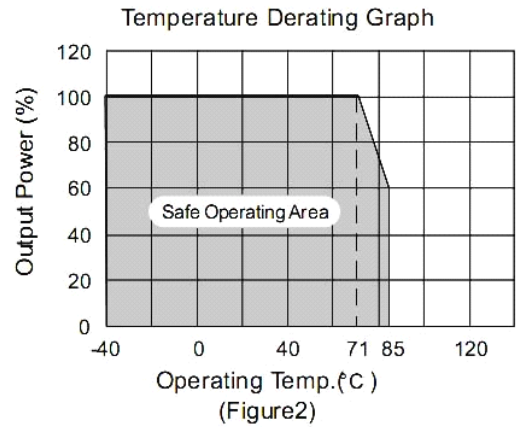

RECOMMENDED REFLOW SOLDERING PROFILE

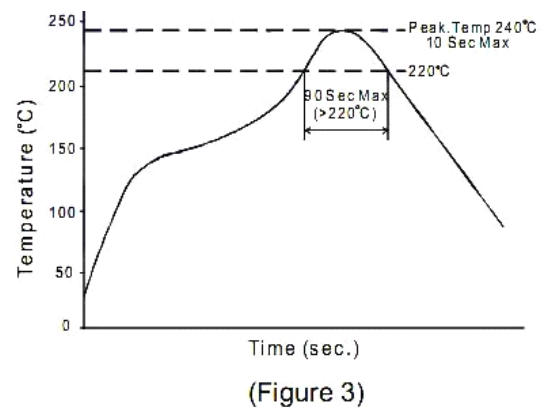

ADJUSTMENT RESISTOR VALUES

Part Number	WRN7803T-1000		WRN7805T-1000	
	3.3(V)		5.0(V)	
Vo (nominal)	R1(KΩ)	R2(KΩ)	R1(KΩ)	R2(KΩ)
Vadj(V)				
1.8	15.4	-	-	-
2.5	87	-	9.7	-
3.0	339	-	30.5	-
3.3	-	-	48.8	-
3.6	-	121	75	-
3.9	-	51.0	115	-
4.5	-	16.6	338	-
4.9	-	8.0	1835	-
5.0	-	6.5	-	-
5.1	-	5.2	-	426
5.5	-	1.1	-	58.7
6.0	-	-	-	16.9
6.5	-	-	-	3.2

The R1, R2 in the above table are used to set the output voltage. If no need to adjust the output voltage, connect a ceramic capacitor to GND with 470pF typical value for increase immunity. Insure the output voltage is in the adjust range or else may cause permanent damage to the device. Fine-tune output voltage must appease $V_{in}-V_o > 2V$.

EMC RECOMMENDED CIRCUIT

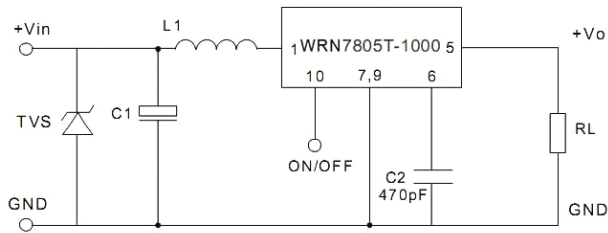

(Figure 4)

Specifications: TVS: SMCJ18A,1500W; L1: 68 μ H; C1: 680 μ F/50V electrolytic capacitors.

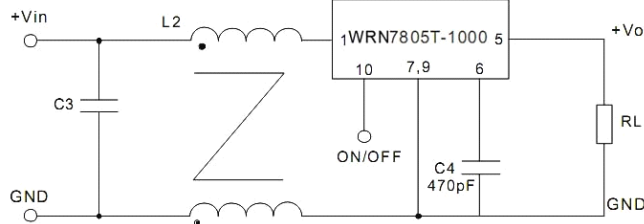

(Figure 5)

Specifications: L2: 516 μ H; C3: 1 μ F/50V ceramic capacitor.

TEST CONFIGURATIONS (TA=25°C)

1 Efficiency and Output Voltage Ripple Test

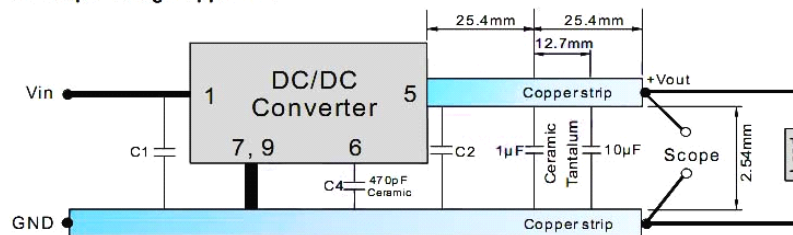

(Figure 6)

2 Start-up and Load Transient Response Test

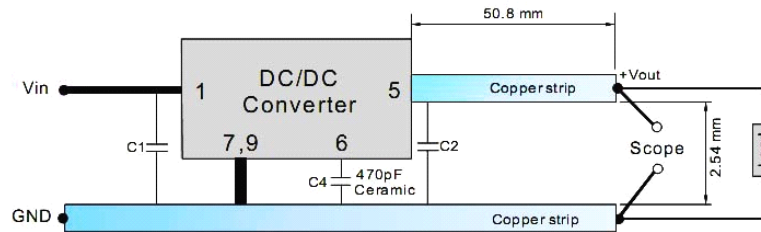

(Figure 7)

APPLICATION EXAMPLE

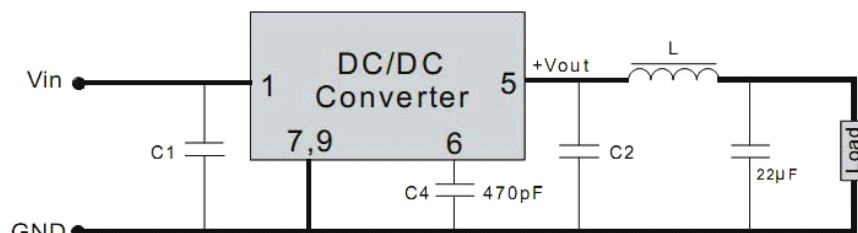

(Figure 8)

To reduce output ripple, it is recommended to add a LC filter to output port.

L: Recommended parameter 10 μ H ~ 47 μ H.

CHARACTERISTIC CURVE

Efficiency

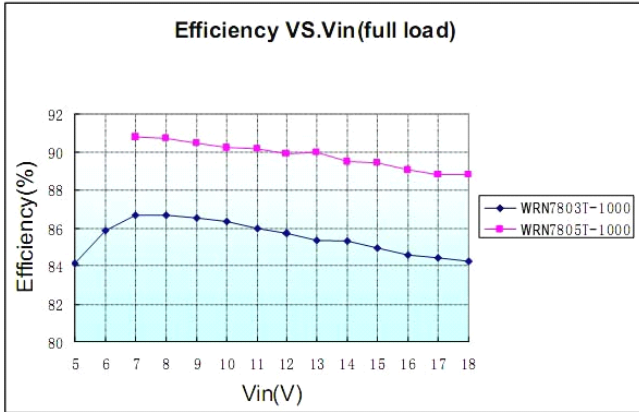

Ripple

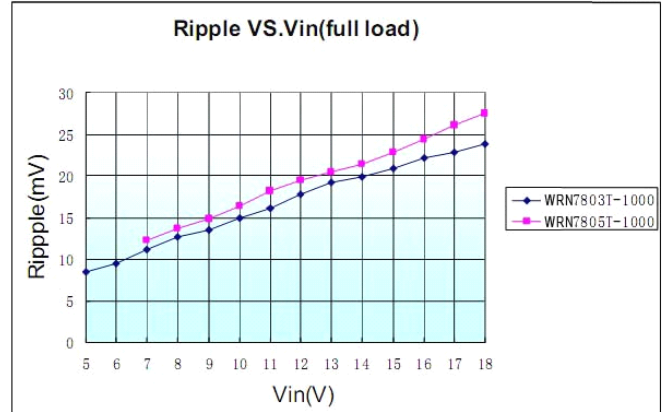

Efficiency VS.Load(Vin=Vin-nominal)

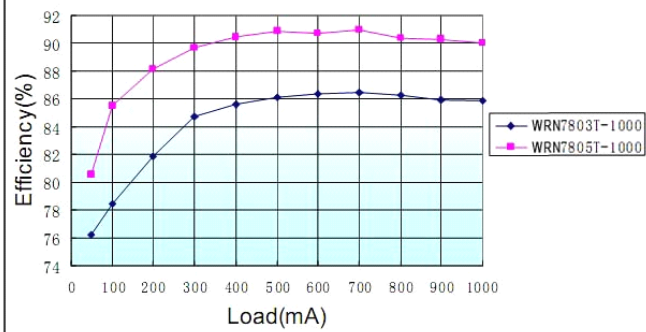

Ripple VS.Load(Vin=Vin-nominal)

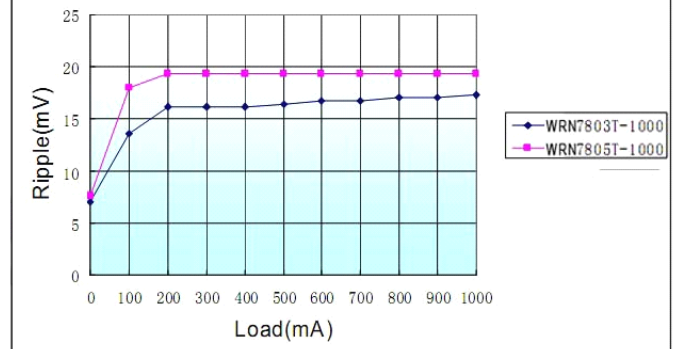

EMC TESTING WAVE SHAPE

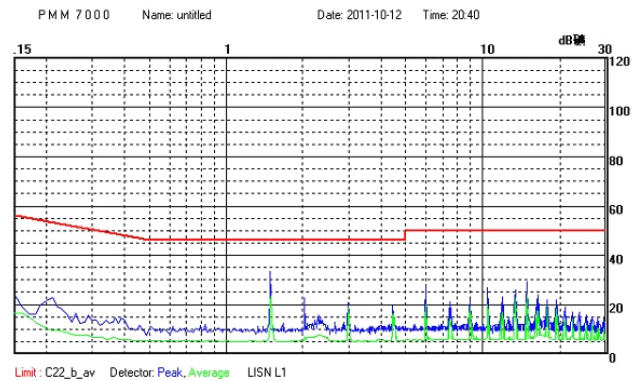
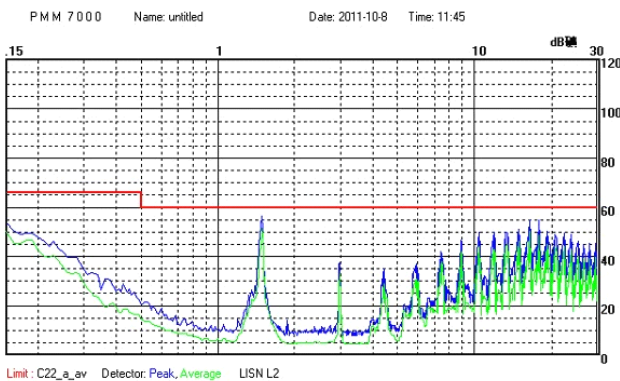

OUTLINE DIMENSIONS & RECOMMENDED FOOTPRINT & PACKAGING

MECHANICAL DIMENSIONS

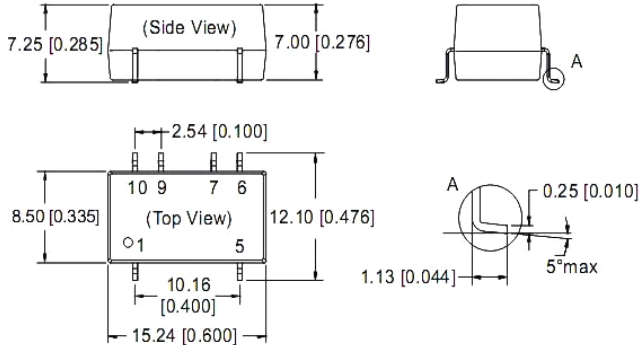

Note:
Unit:mm[inch]
Pin tolerances:±0.10mm[±0.004inch]
General tolerances:±0.25mm[±0.010inch]

RECOMMENDED FOOTPRINT

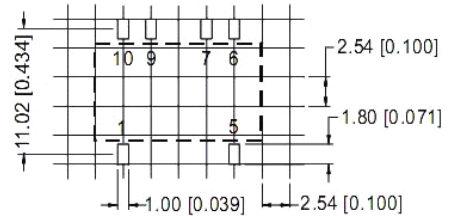

FOOTPRINT DETAILS	
Pin	Function
1	Vin
7,9	GND
5	Vout
6	Vadj
10	ON/OFF

TUBE OUTLINE DIMENSIONS

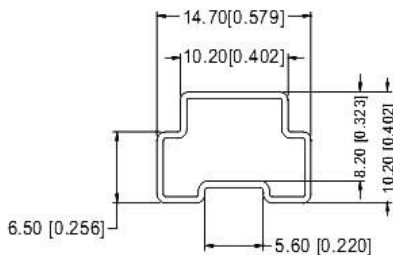

Note:
Unit :mm[inch]
General tolerances: ±0.50mm[±0.020inch]
L=530mm[20.866inch] Devices per tube quantity: 33pcs
L=220mm[8.661inch] Devices per tube quantity: 13pcs
Short tube inner packaging dimensions: L*W*H=255*170*80mm;
Short tube outer packaging dimensions(with six inner packaging boxes):
L*W*H=375*280*270mm;
Long tube inner packaging dimensions: L*W*H=580*200*100mm;
Long tube outer packaging dimensions(with two inner packaging boxes):
L*W*H=600*215*220mm;
Long tube outer packaging dimensions(with three inner packaging boxes):
L*W*H=600*215*325mm.

TAPING REEL DIMENSIONS

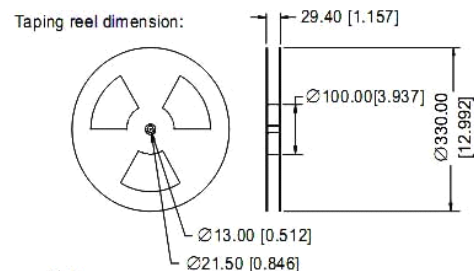
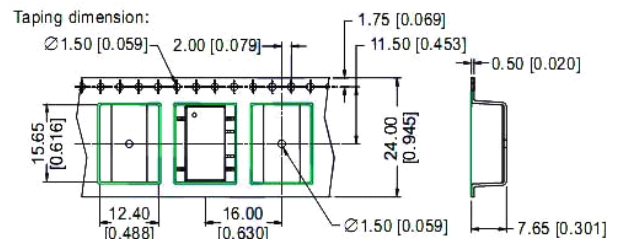

Note:
Unit :mm[inch]
General tolerances: ±0.50mm[±0.020inch]
Devices per reel quantity:500pcs
Inner packaging dimensions: L*W*H=365*350*105mm;
Devices per tube quantity: 2000pcs
Outer packaging dimensions: L*W*H=390*360*245mm.
Devices per tube quantity: 4000pcs

RoHS COMPLIANT INFORMATION

This series is compatible with RoHS soldering systems with a peak wave solder temperature of 300° C for 10 seconds.
The pin termination finish on the SIP package type is Tin Plate, Hot Dipped over Matte Tin with Nickel Preplate. The DIP types are Matte Tin over Nickel Preplate. Both types in this series are backward compatible with Sn/Pb soldering systems.

REACH COMPLIANT INFORMATION

This series has proven that this product does not contain harmful chemicals, it also has harmful chemical substances through the registration, inspection and approval.